

3015R\_US\_FL(AC02154) TRACTOR

## Parts Catalogue



# CONTENTS

GROUP NO	GROUP NAME	PAGE
G. ENGINE		
A01_004	CYLINDER BLOCK	6
A02_005	DRIVE PULLY	8
A03_002	CRANK SHAFT PULLEY	10
A04_004	GLOW PLUG ASS'Y OPTION	12
A05_003	CRANK SHAFT ASS'Y OPTION	14
A06_002	BREATHER OPTION	16
A07_002	CAMSHAFT	18
A08_003	ALTERNATOR	20
A09_003	COOLING WATER PUMP	22
A10_003	COOLING FAN SPACER	24
A11_005	INJECTOR	26
A12_003	FUEL INJECTON	28
A13_002	PLUMBING, FUEL	30
A14_001	FUEL FILTER BRACKET	32
A16_018	FUEL FILTER ASS'Y OPTION	34
A17_005	INTAKE MANIFOLD ASS'Y OPTION	36
A18_005	FLYWHEEL	38
A19_005	FLYWHEEL HOUSING	40
A20_007	HEAD, CYLINDER	42
A21_002	HEAD COVER	44
A23_003	TURBOCHARGER SUPPORT ASS'Y OPTION	46
A26_001	COOLER, ENGINE OIL	48
A27_004	OIL PAN ASS'Y OPTION	50
A28_001	PUMP, LUBRICATING OIL	52
A29_005	FILTER, LUBRICATING OIL	54
A30_003	FRONT GEAR ACCESSORY DRIVE	56
A31_003	PISTON	58
A32_002	LEVER, LOCKER	60
A33_006	EXHAUST MANIFOLD	62
A35_002	IDLE GEAR	64
A36_002	COVER, FRONT GEAR	66
A38_004	GAUGE, OIL LEVEL	68
A39_001	OIL FILLER CAP	70
A40_003	LIFT ASS'Y OPTION	72

# CONTENTS

GROUP NO	GROUP NAME	PAGE
<b>G. ENGINE</b>		
A42_003	MOTER, STARTIONS	74
A43_001	DPF SUPPORT OPTION	76
A44_003	DPF MOUNTING OPTION	78
A45_011	DPF	80
A48_006	V-BELT	82
<b>B. ENGINE ACCESSORIES</b>		
B01010	(FUEL TANK)	84
B02020	(RADIATOR)	86
B03010	(AIR CLEANER)	88
B05011	(LEVER ACCELERATOR)	90
<b>C. CLUTCH, BREAK, LEVER</b>		
C02010-B	(BRAKE PEDAL)	92
C02050	(PARKING BRAKE)	94
C04010	(SHUTTLE ASS'Y)	96
<b>D. HYDRAULIC</b>		
D01010-A	(HYD PUMP)	98
D01020-A	(LOW PRESSURE PIPE)	100
D01040	(HYD FILTER)	102
D02010	(STEERING COLUMN)	104
D02030	(P.S.T HOSE)	106
D02040	(P.S.T CYLINDER)	108
<b>E. FRONT AXLE</b>		
E01010	(FRONT AXLE CASE)	110
E01013	(SPACER)	112
E01030	(GEAR CASE, FRONT AXLE)	114
E01070	(FRONT DRIVE SHAFT)	116
E01080	(TIE ROD)	118
<b>F. TRANSMISSION</b>		
F01010-B	(CLUTCH HOUSING)	120
F01020	(TRANSMISSION CASE)	122
F01030	(REAR AXLE HOUSING)	124
F02010	(CLUTCH RELEASE)	126
F02020	(CLUTCH SHAFT)	128
F03010	(MAIN SHIFT DRIVE SHAFT)	130

# CONTENTS

GROUP NO	GROUP NAME	PAGE
<b>F. TRANSMISSION</b>		
F03040	(RANGE SHIFT DRIVE SHAFT)	132
F04010	(FRONT DRIVE SHAFT)	134
F05020	RING GEAR&DIFF.GEAR ASS'Y	136
F05020	(REAR DIFFERENTIAL ASS'Y)	138
F06030	(BRAKE)	140
F07030	(PTO DRIVE SHAFT)	142
F07070	(MAIN P.T.O SHAFT)	144
F08021	(FORK, PTO SHIFT)	146
F08060	(FORK, MAIN SHIFT)	148
F10010	(CASE, HYD CYLINDER)	150
F10020	(LIFT ARM)	152
F10030	(SAFETY VALVE)	154
F10031	(RELIEF)	156
F10040	(STOP VALVE)	158
F10061	(DRAFT/POSITION CONTROL LEVER)	160
F10063	(DRAFT CONTROL)	162
F10064	(POSITION CONTROL LEVER)	164
F11020	(LEVER ASS'Y, RANGE SHIFT)	166
F11060	(DIFFERENTIAL LOCK)	168
F11080	(4WD LEVER)	170
<b>G. SHEET METAL, CABIN</b>		
G01020	BONNET	172
G01040	LOCKING ASS'Y, BONNET	174
G01060-B	(BONNET SUPPORT)	176
G01062	FIXED BRACKET, BONNET	178
G01080	FRONT AXLE BRACKET	180
G04060	FOOT REST ASS'Y	182
G04070	SEAT	184
G04090	FENDER	186
G04120	ROPS FRAME ASS'Y	188
G05020	TOP LINK	190
G05030	LOWER LINK	192
G05050	LIFT LINK	194
G05070	DRAWBAR HITCH	196

# CONTENTS

GROUP NO	GROUP NAME	PAGE
G. SHEET METAL, CABIN		
G05090	SIDE COVER	198
G06010	TOOL BOX & CUP HOLDER	200
H. ELECTRICALS, HARNESS		
H01030	BATTERY	202
H03000	HARNESS	204
H04051	SWITCH/DASHBOARD	206
H04070	CONTROLLER	208
I. WEIGHT, TOOLS, TIRE		
I03000	NAME PLATE	210
I06010	SUN VISOR(OPTION)	212

A01\_004

A1700N5-UTR\_4  
(AB00223)

### CYLINDER BLOCK

Year/Month

2022-12-14

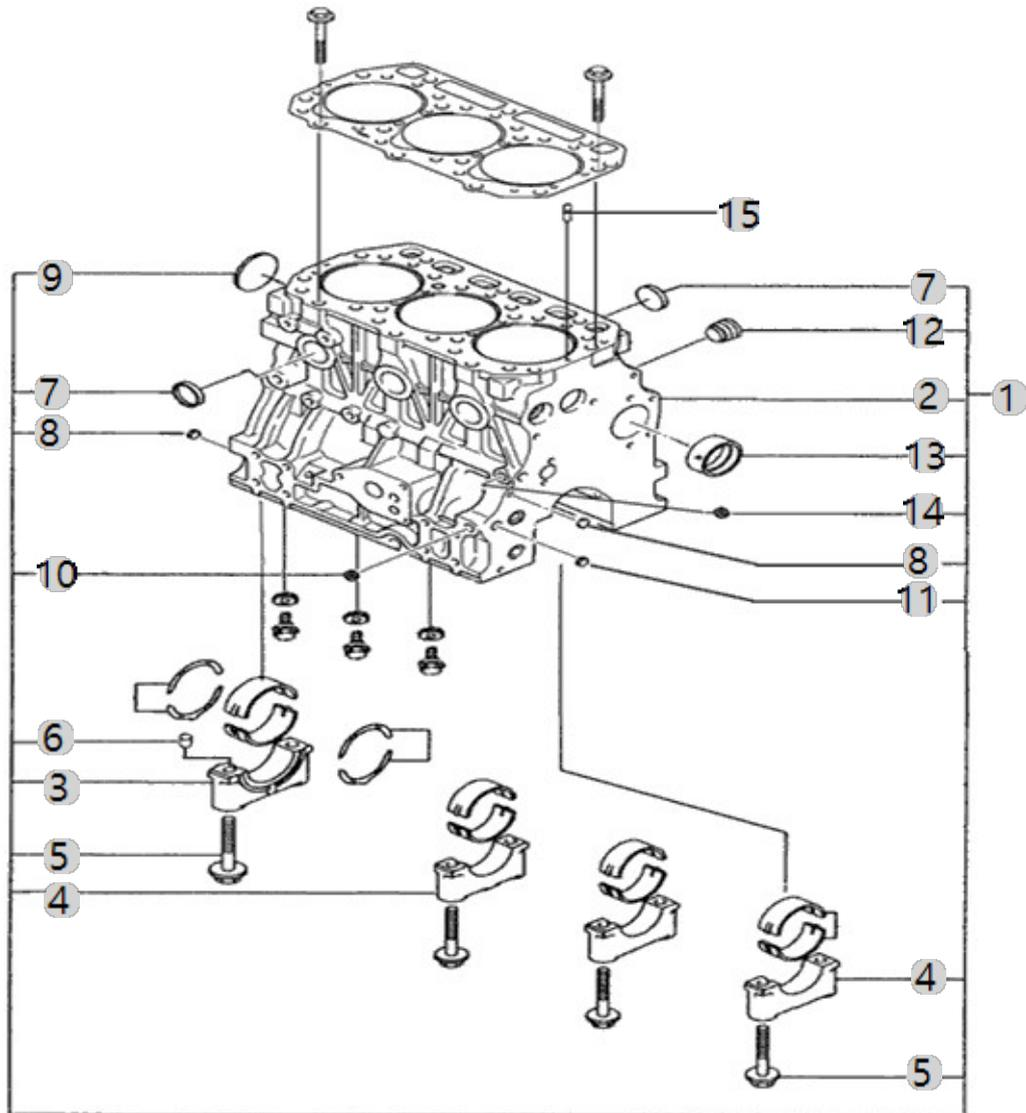



A02\_005

A1700N5-UTR\_4  
(AB00223)

DRIVE PULLY

Year/Month

2022-12-14

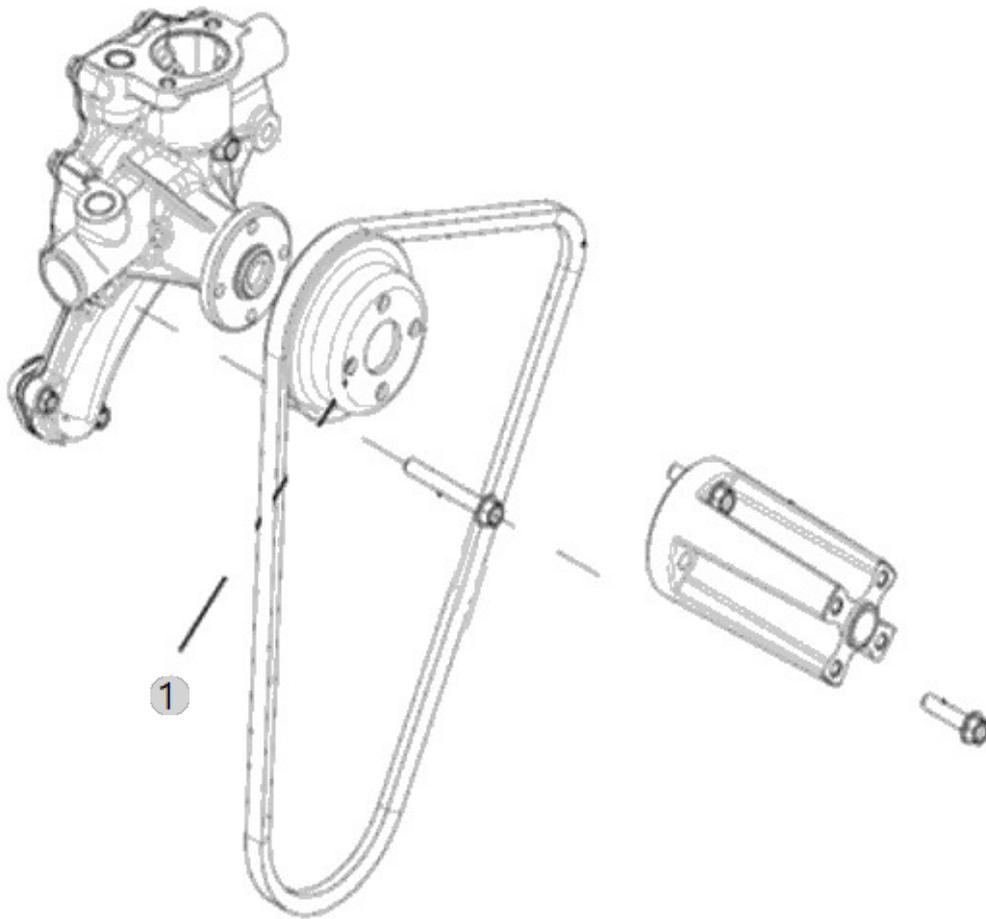





A03\_002

A1700N5-UTR\_4  
(AB00223)

# CRANK SHAFT PULLEY

Year/Month

2022-12-14

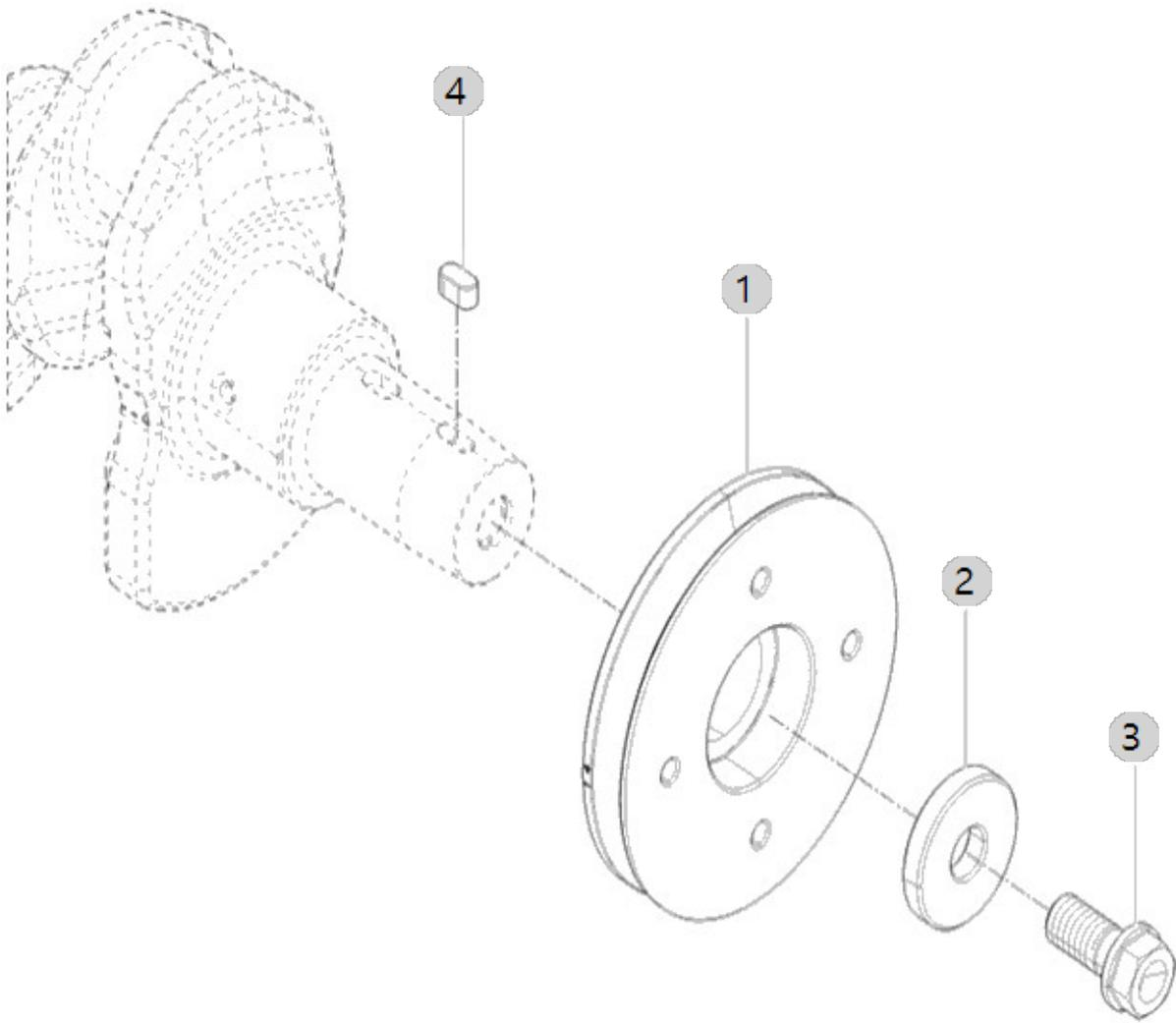



A04\_004

A1700N5-UTR\_4  
(AB00223)

### GLOW PLUG ASS'Y OPTION

Year/Month

2022-12-14

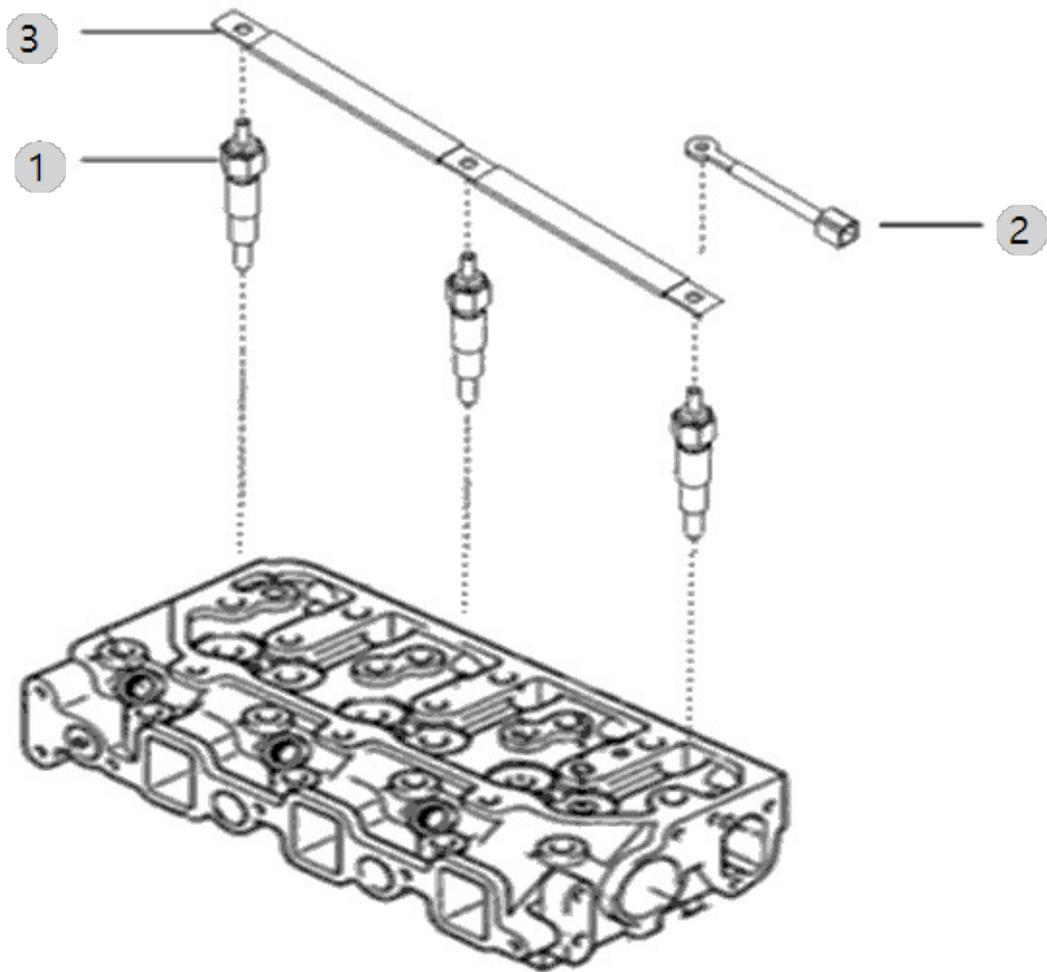



A05\_003

A1700N5-UTR\_4  
(AB00223)

CRANK SHAFT ASS'Y OPTION

Year/Month

2022-12-14

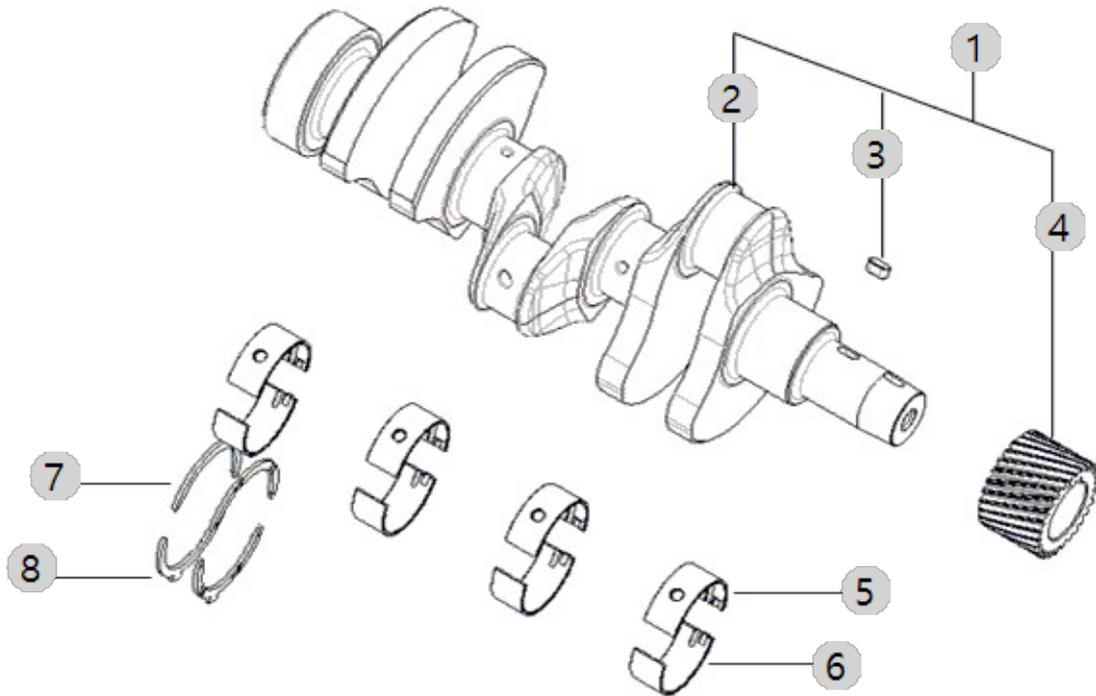



A06\_002

A1700N5-UTR\_4  
(AB00223)

BREATHER OPTION

Year/Month

2022-12-14

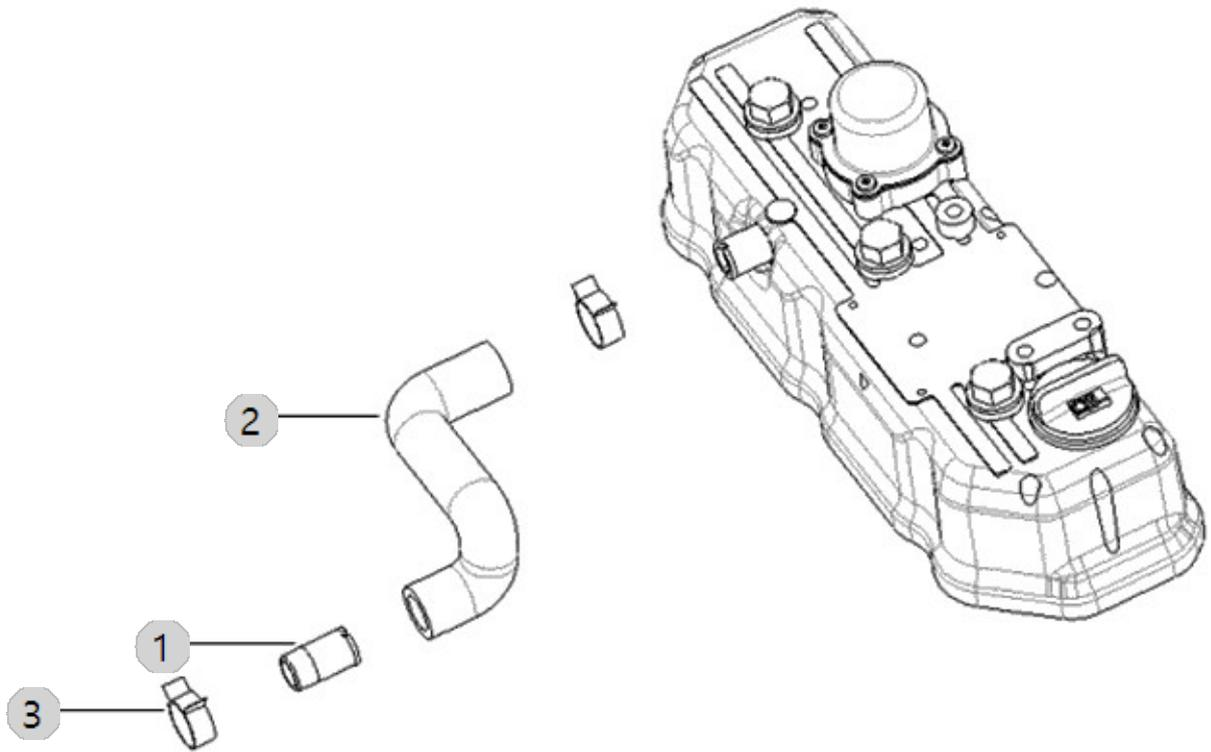





A07\_002

A1700N5-UTR\_4  
(AB00223)

# CAMSHAFT

Year/Month

2022-12-14

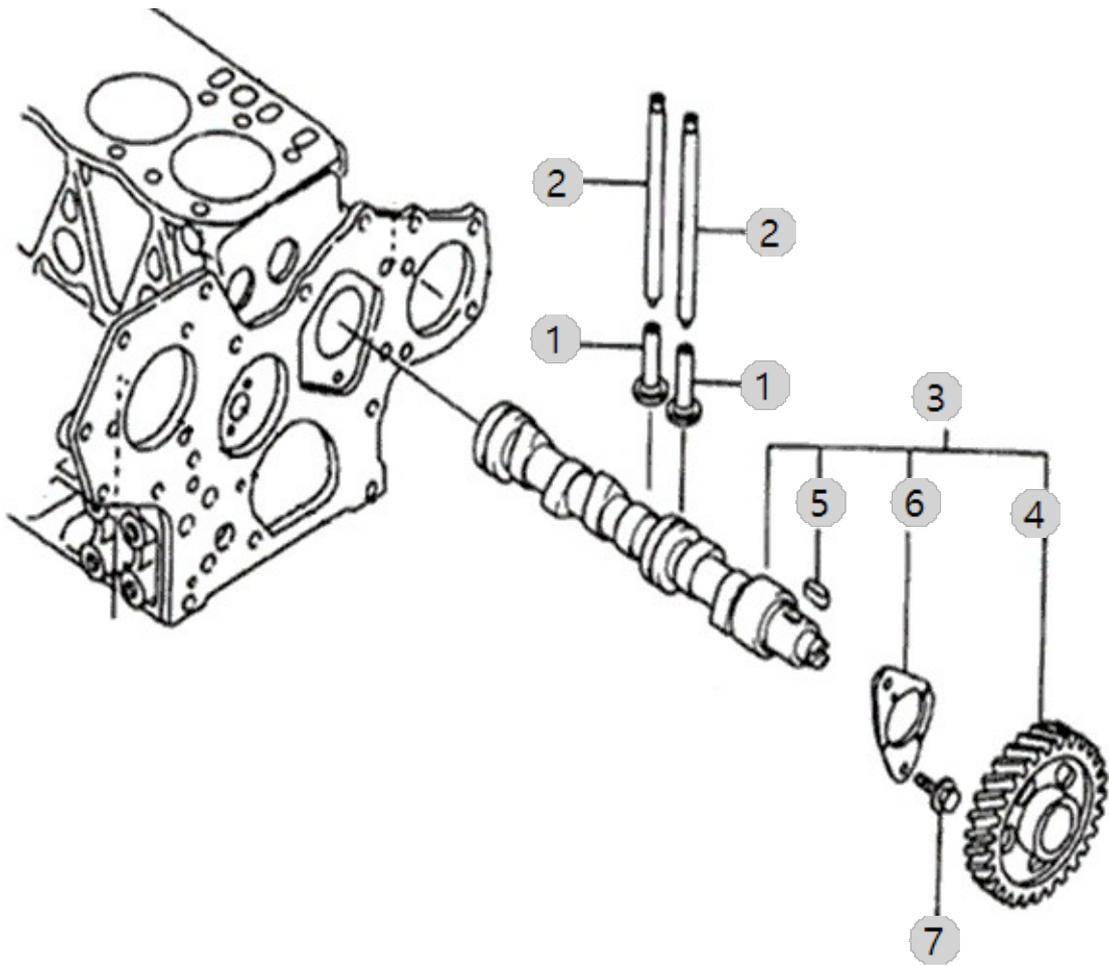



A08\_003

A1700N5-UTR\_4  
(AB00223)

# ALTERNATOR

Year/Month

2022-12-14

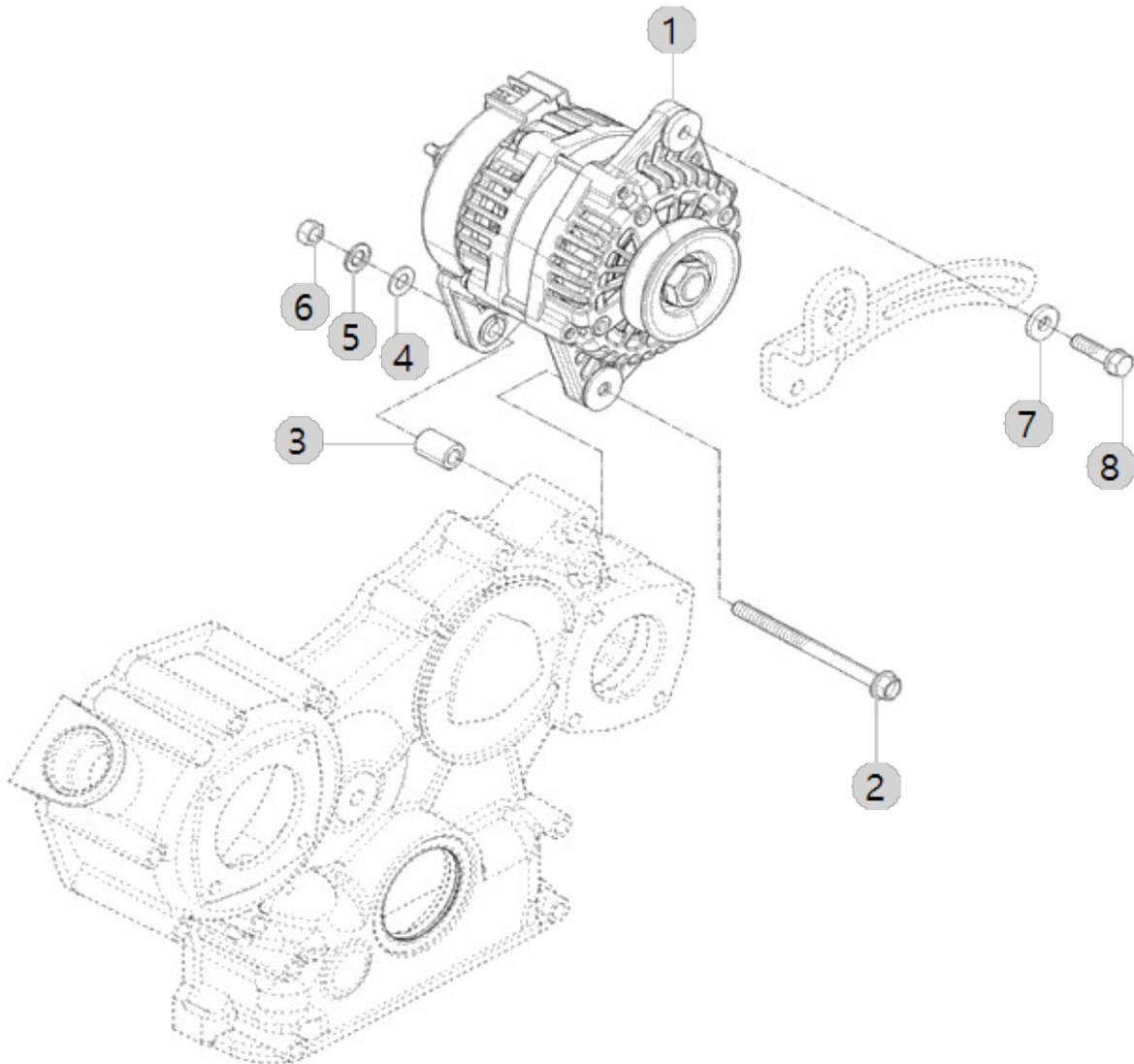



A09\_003

A1700N5-UTR\_4  
(AB00223)

### COOLING WATER PUMP

Year/Month

2022-12-14

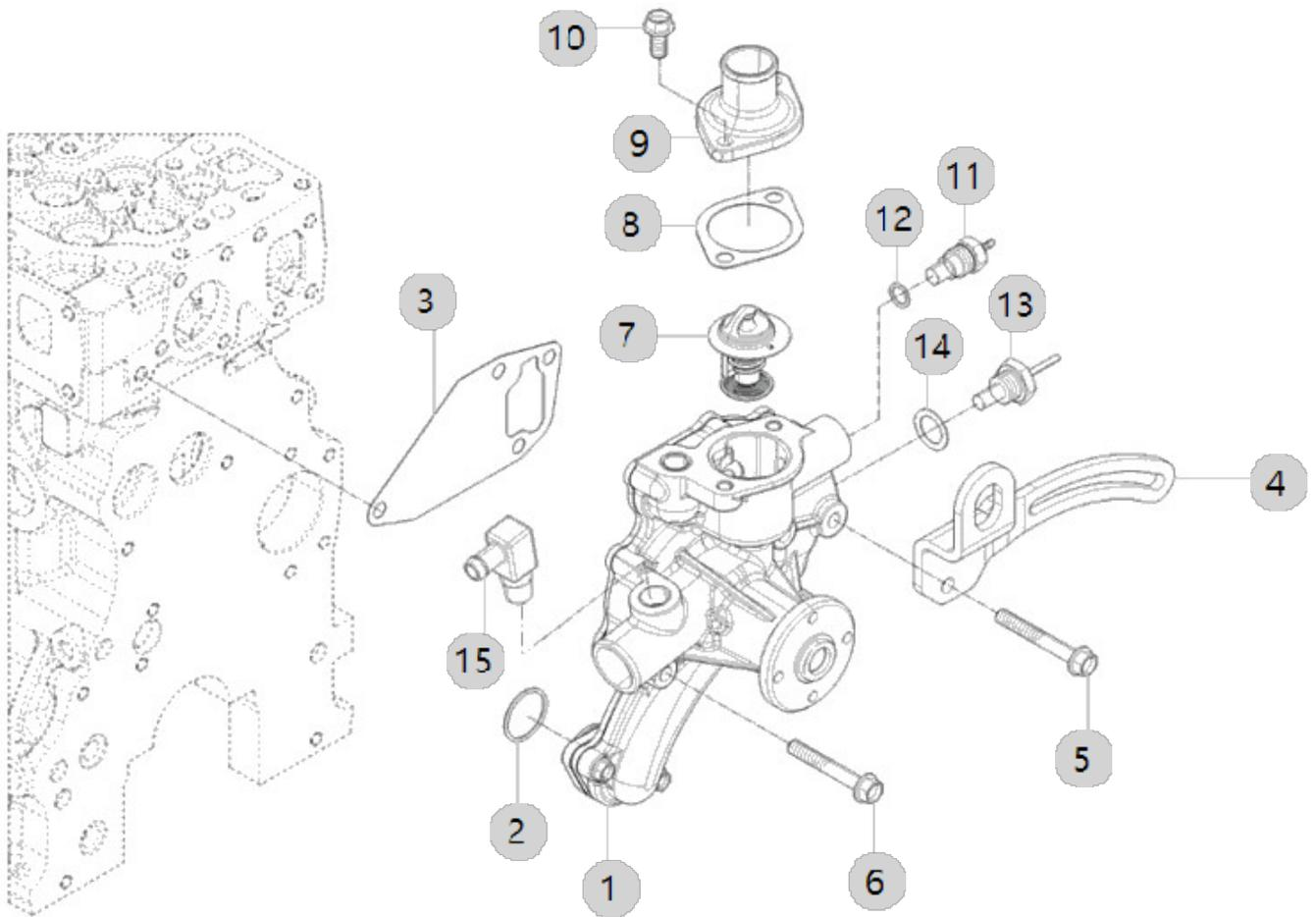



A10\_003

A1700N5-UTR\_4  
(AB00223)

COOLING FAN SPACER

Year/Month

2022-12-14

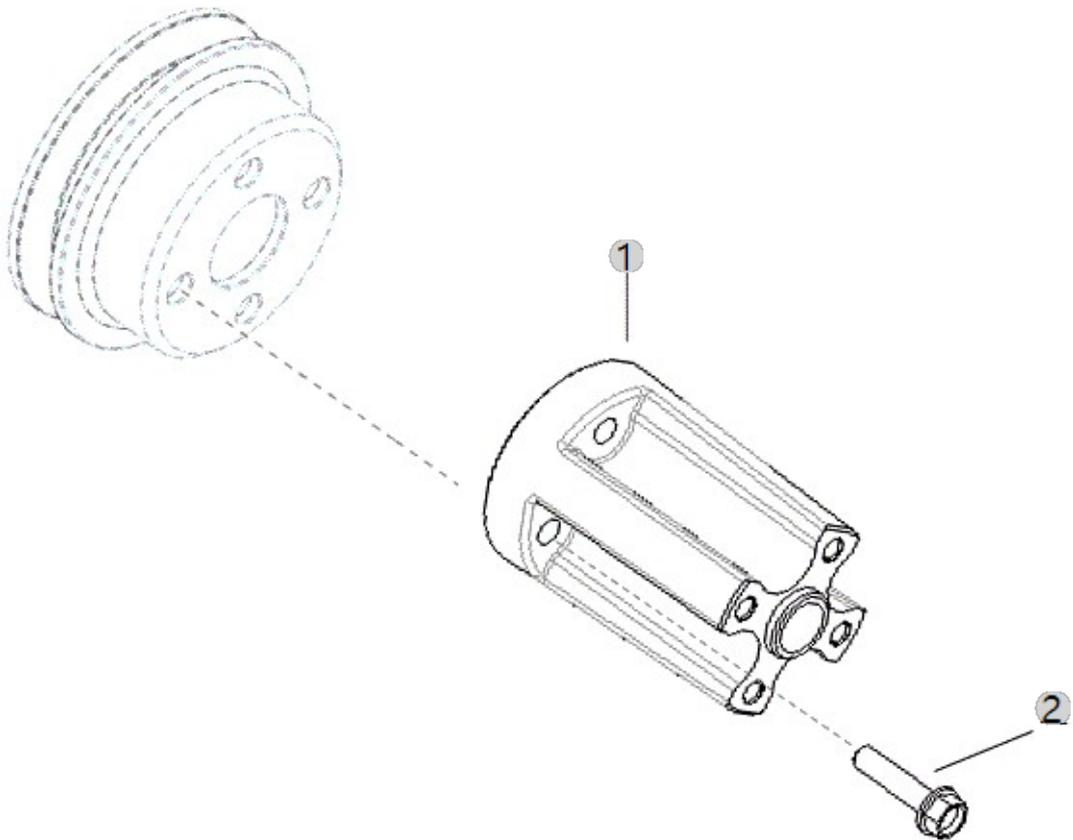





A11\_005

A1700N5-UTR\_4  
(AB00223)

# INJECTOR

Year/Month

2022-12-14

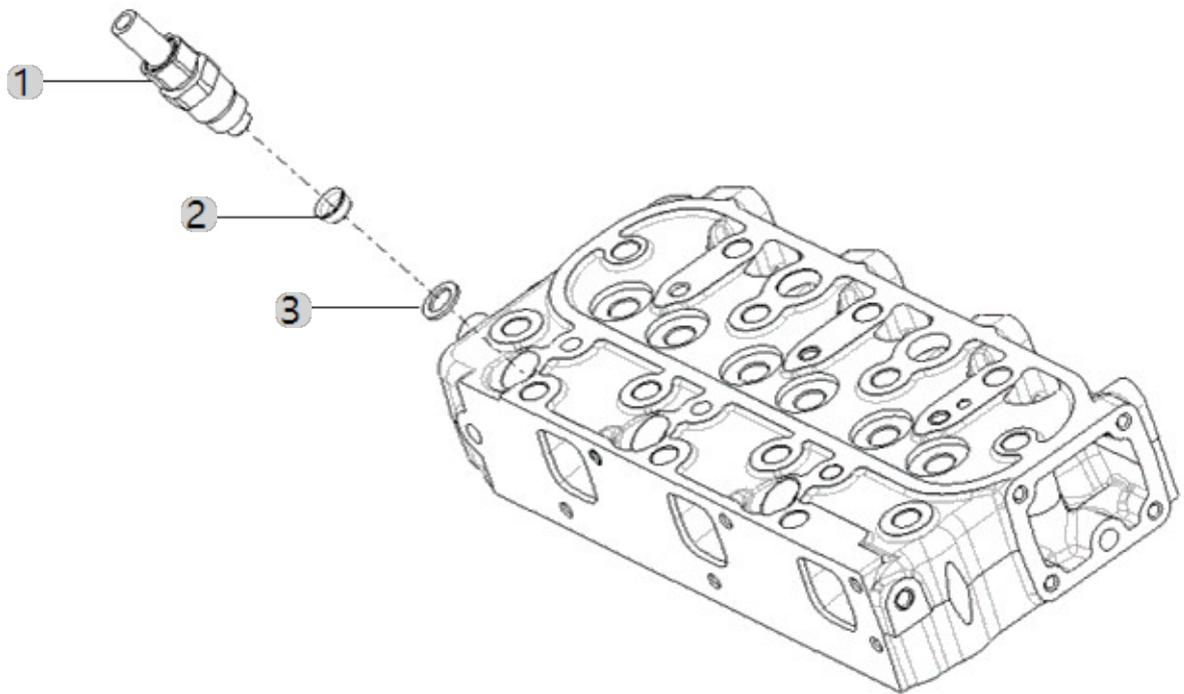



A12\_003

A1700N5-UTR\_4  
(AB00223)

# FUEL INJECTOR

Year/Month

2022-12-14

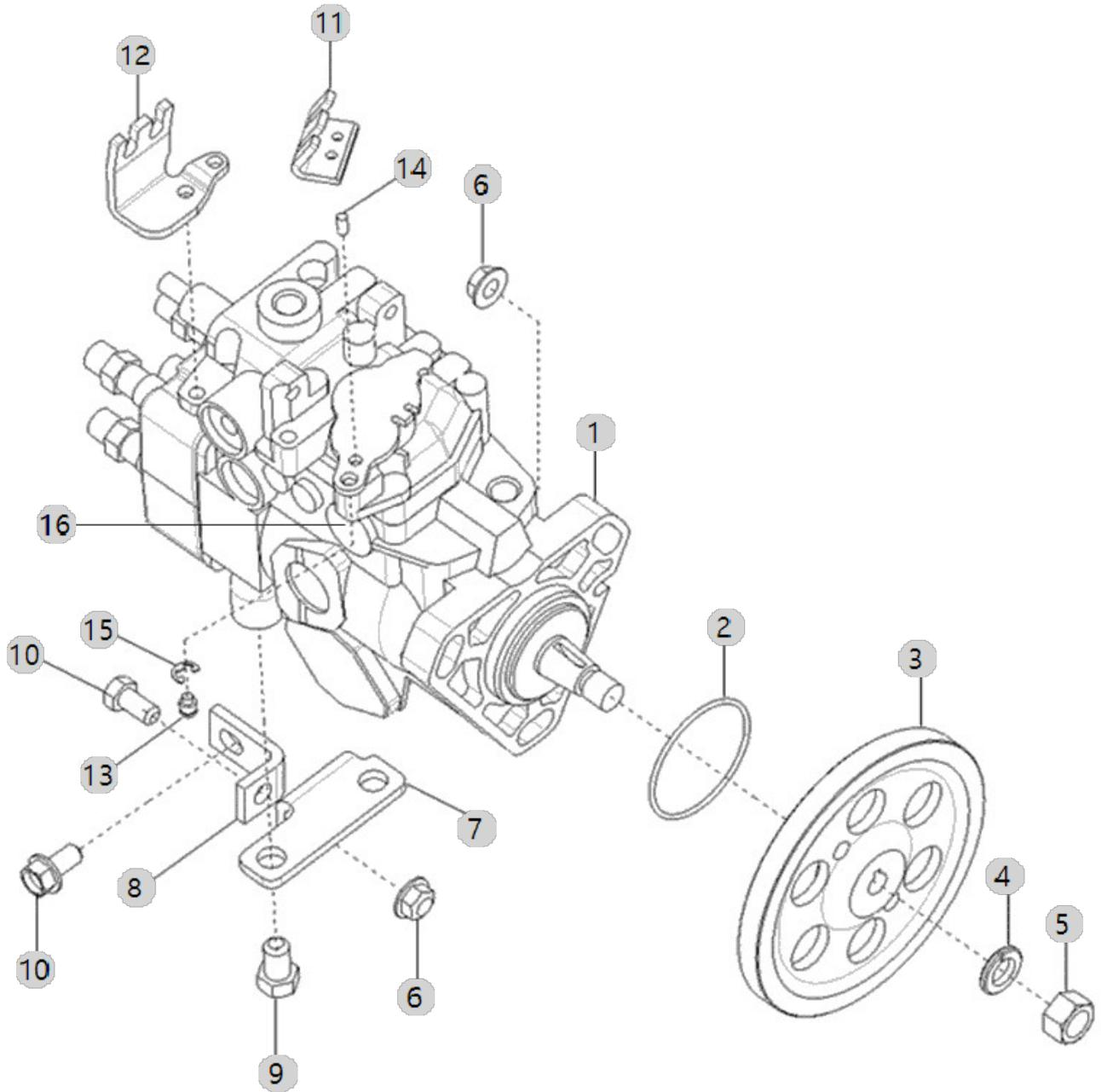



A13\_002

A1700N5-UTR\_4  
(AB00223)

PLUMBING, FUEL

Year/Month

2022-12-14

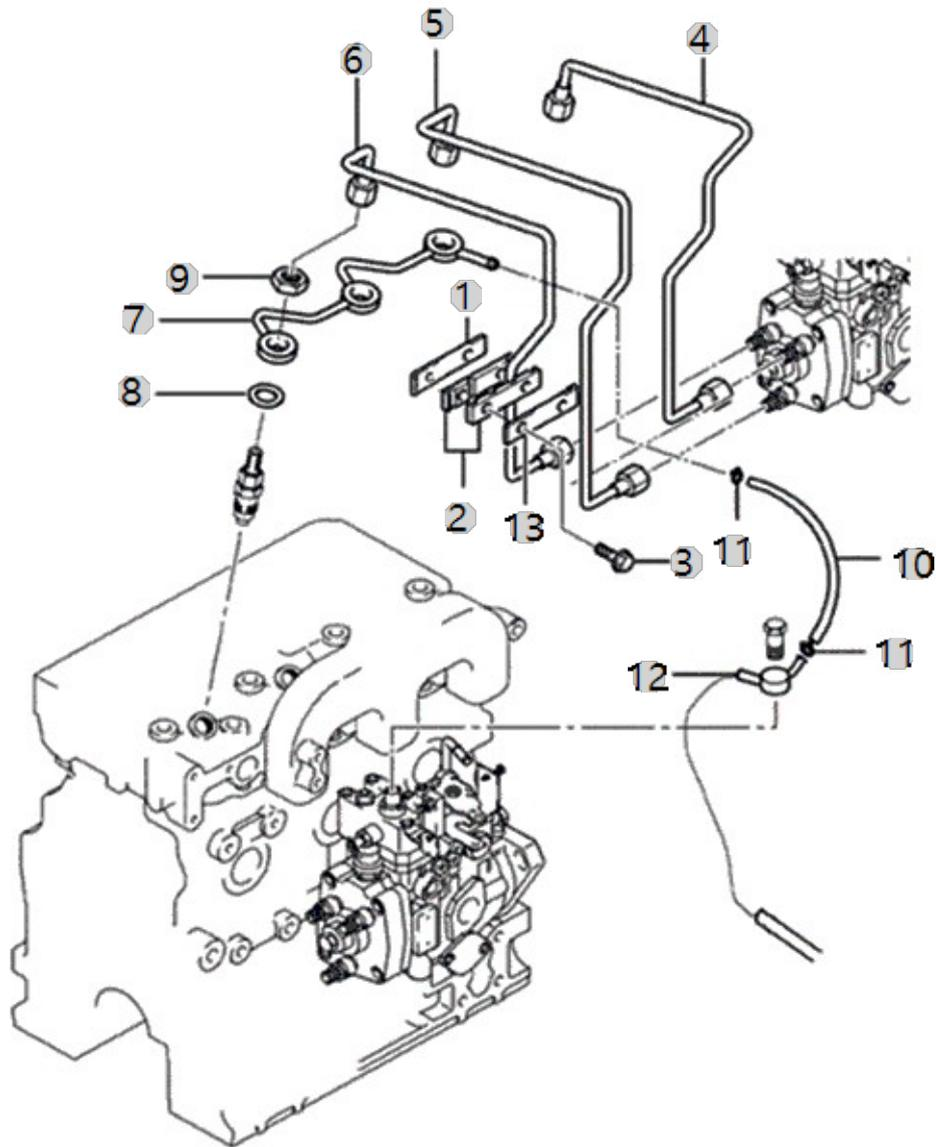



A14\_001

A1700N5-UTR\_4  
(AB00223)

FUEL FILTER BRACKET

Year/Month

2022-12-14

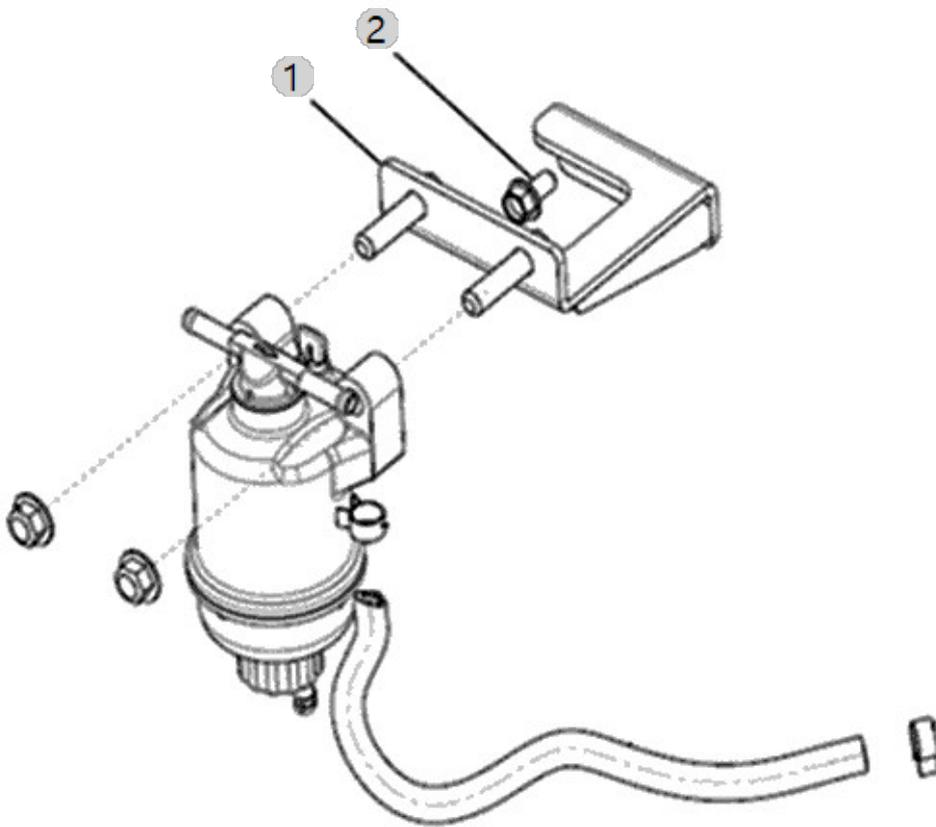





A16\_018

A1700N5-UTR\_4  
(AB00223)

FUEL FILTER ASS'Y OPTION

Year/Month

2022-12-14

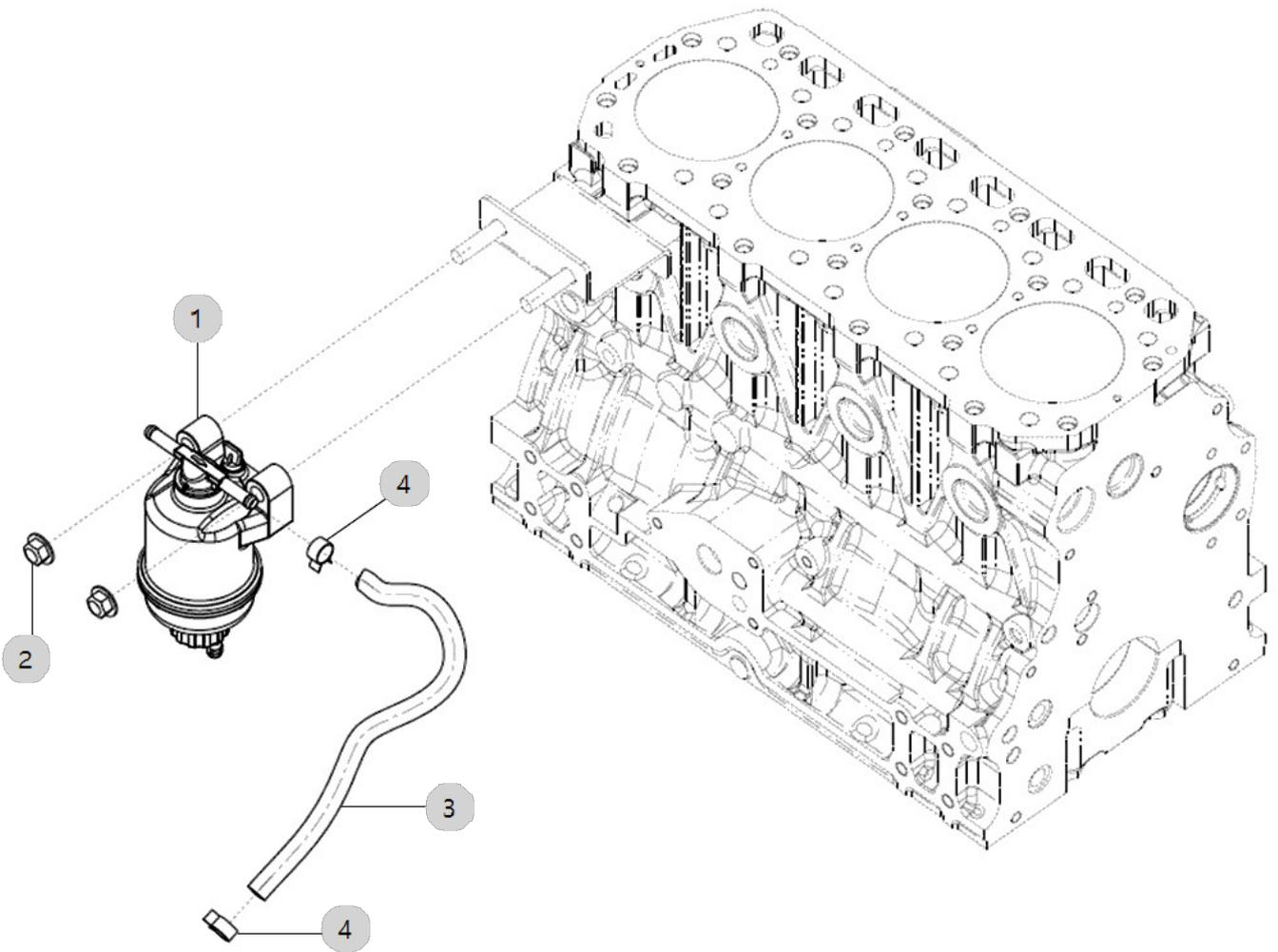



A17\_005

A1700N5-UTR\_4  
(AB00223)

INTAKE MANIFOLD ASS'Y OPTION

Year/Month

2022-12-14

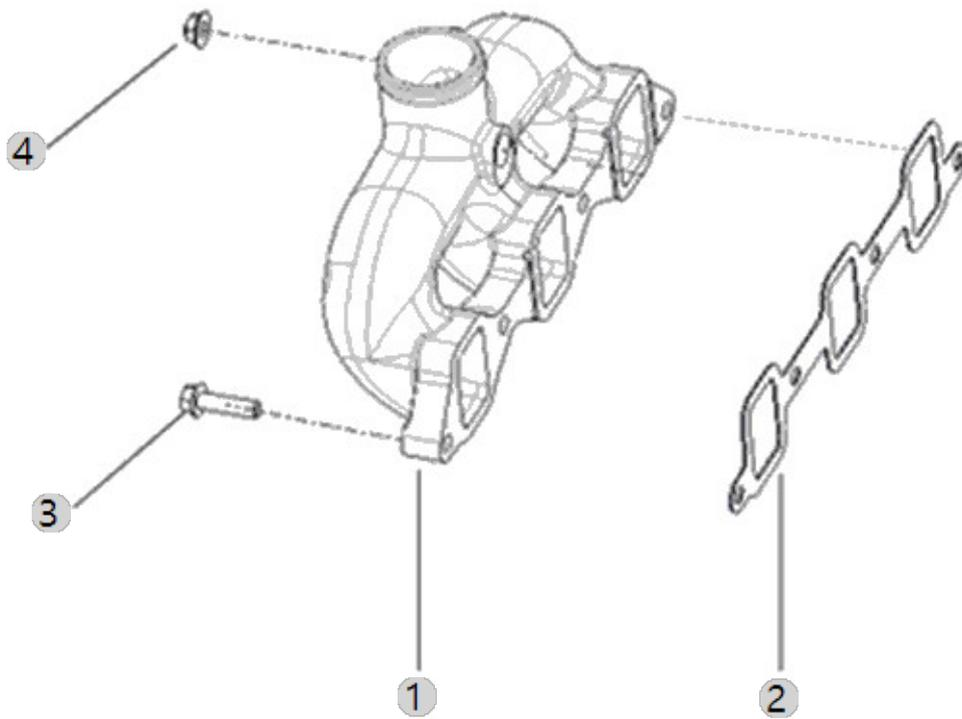



A18\_005

A1700N5-UTR\_4  
(AB00223)

# FLYWHEEL

Year/Month

2022-12-14

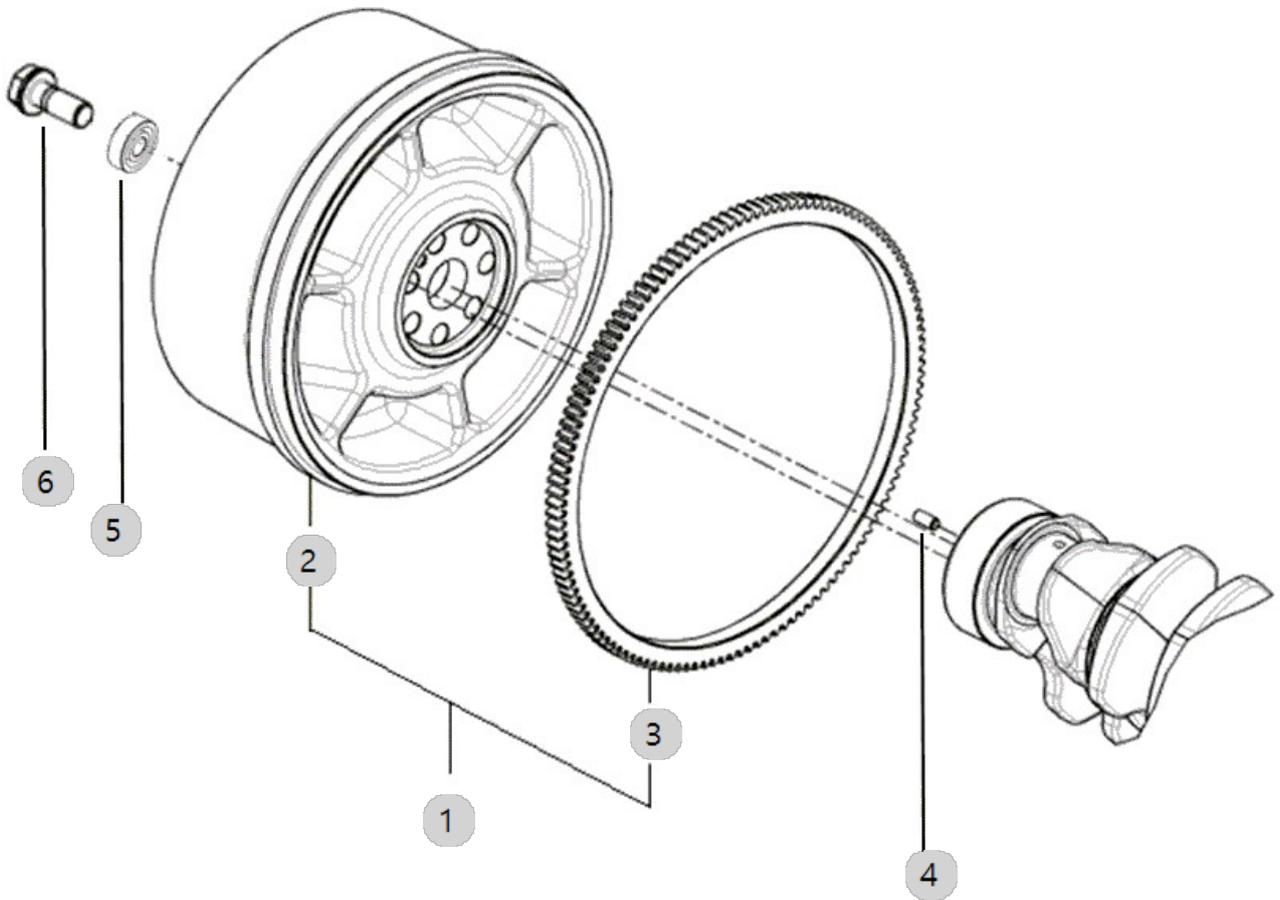



A19\_005

A1700N5-UTR\_4  
(AB00223)

# FLYWHEEL HOUSING

Year/Month

2022-12-14

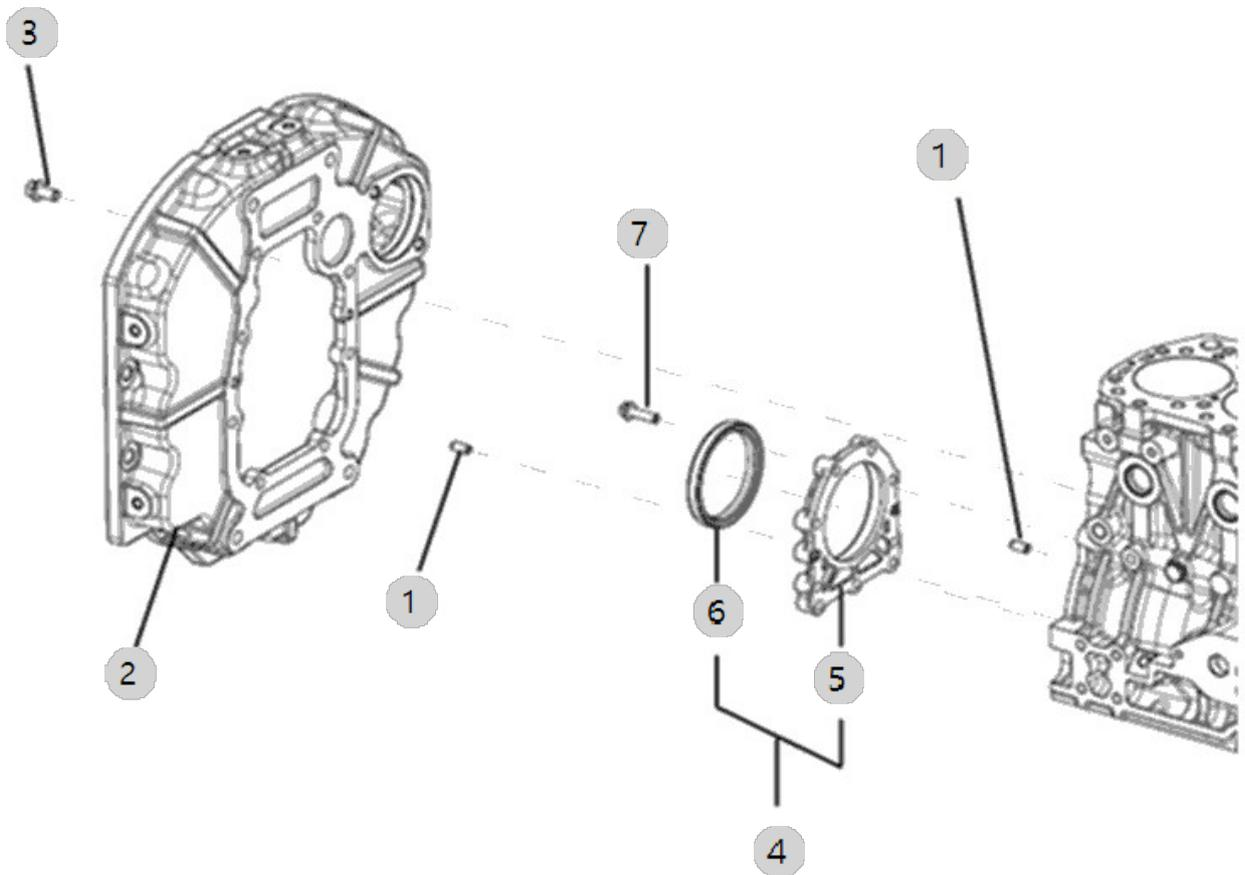





A20\_007

A1700N5-UTR\_4  
(AB00223)

# HEAD, CYLINDER

Year/Month

2022-12-14

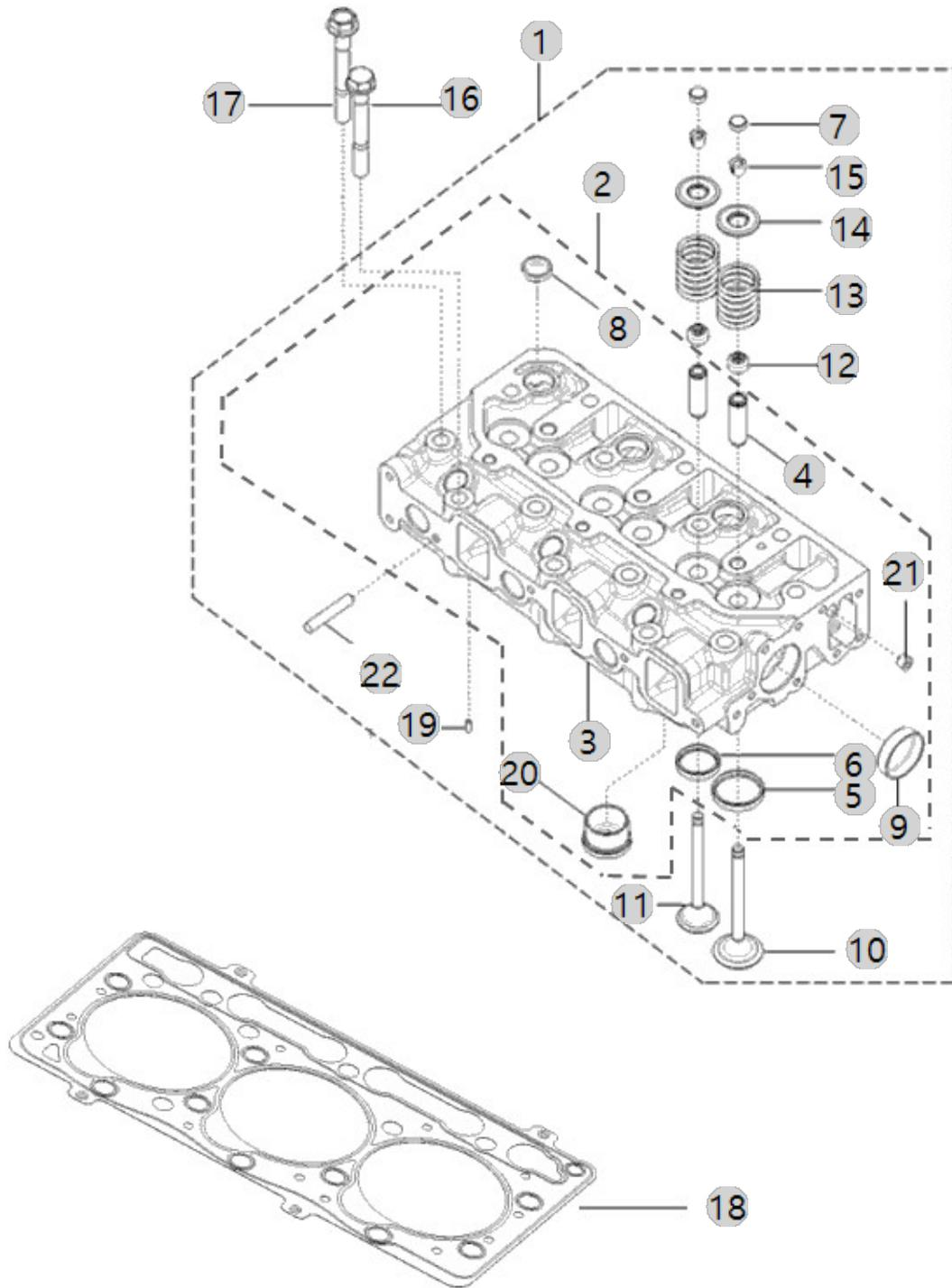



A21\_002

A1700N5-UTR\_4  
(AB00223)

# HEAD COVER

Year/Month

2022-12-14

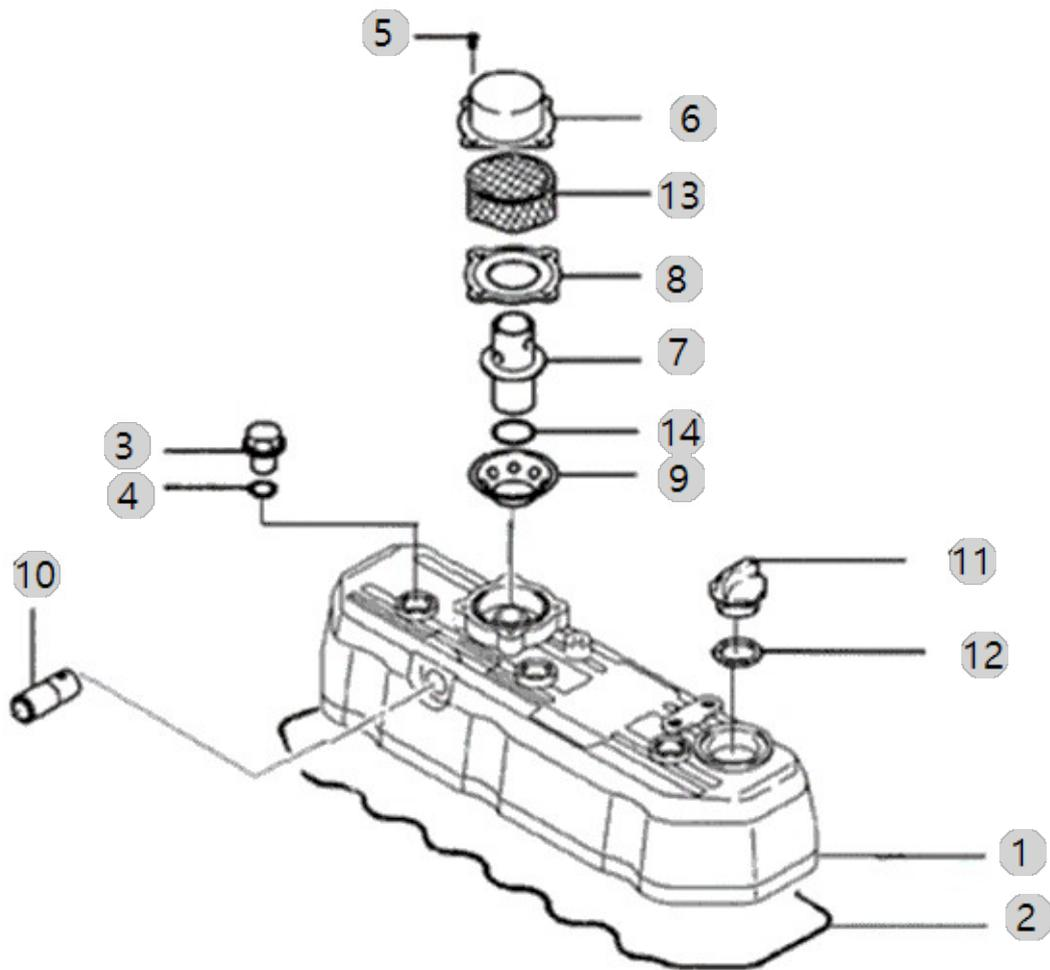



A23\_003

A1700N5-UTR\_4  
(AB00223)

TURBOCHARGER SUPPORT ASS'Y OPTION

Year/Month

2022-12-14

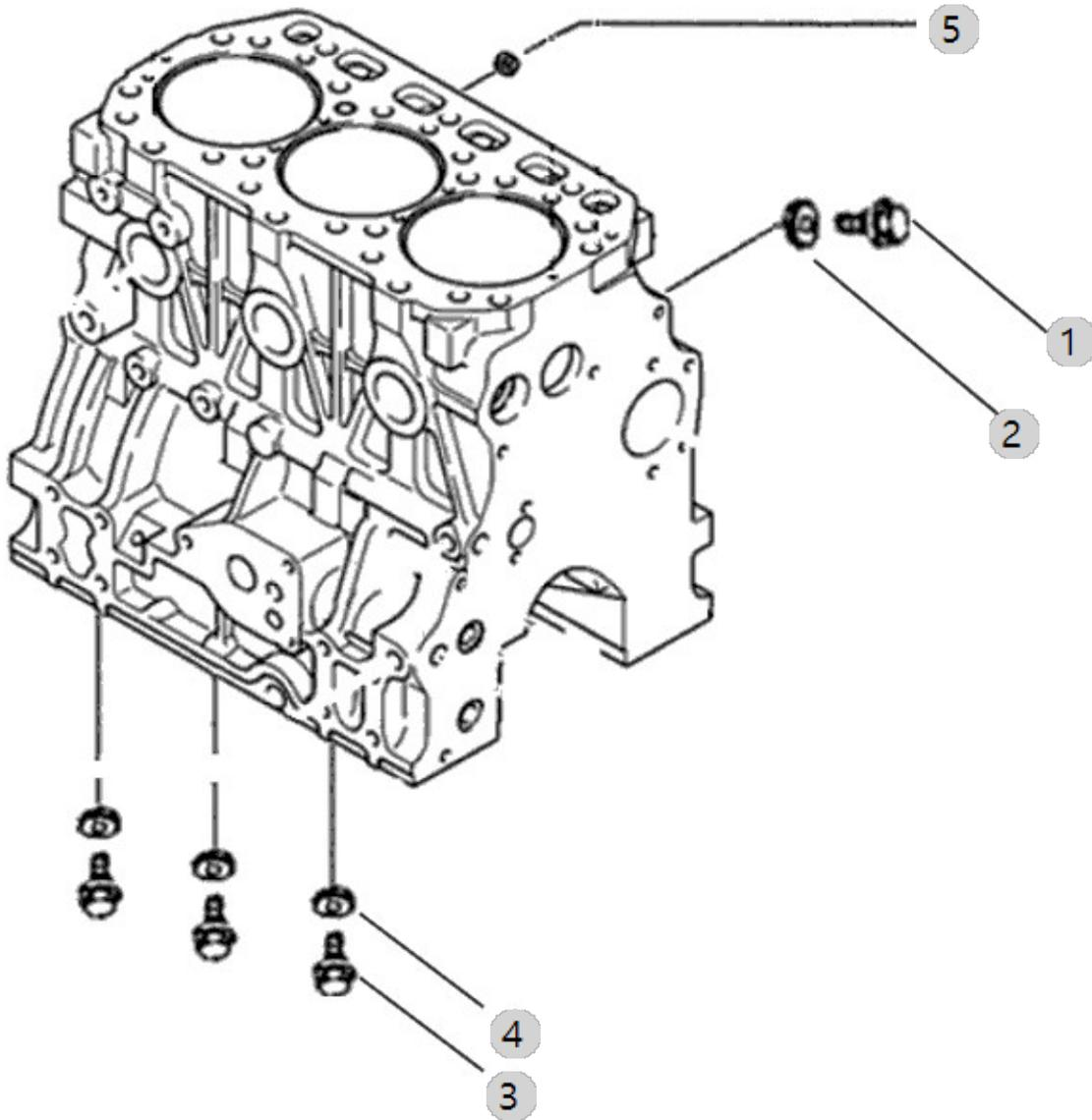



A26\_001

A1700N5-UTR\_4  
(AB00223)

COOLER, ENGINE OIL

Year/Month

2022-12-14

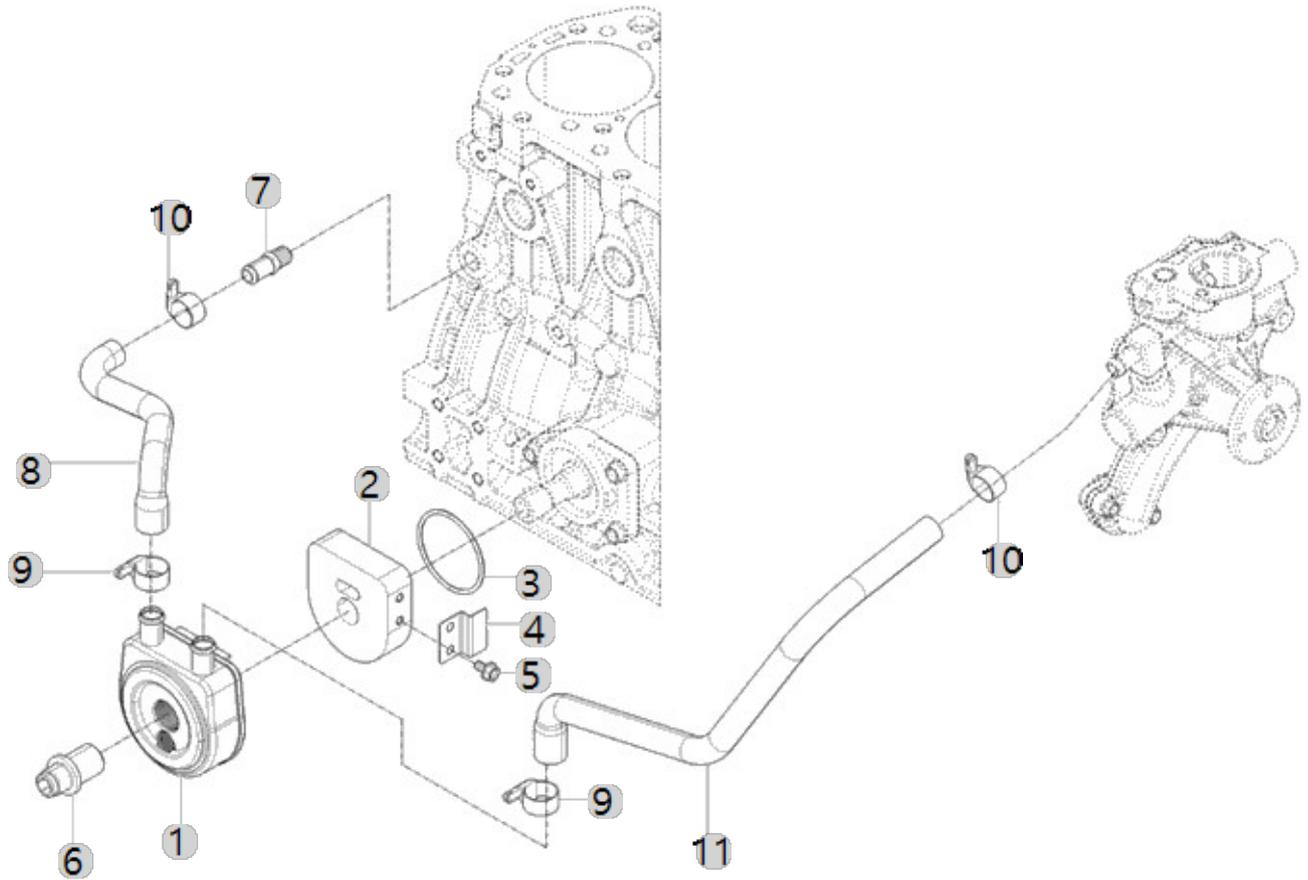





A27\_004

A1700N5-UTR\_4  
(AB00223)

### OIL PAN ASS'Y OPTION

Year/Month

2022-12-14

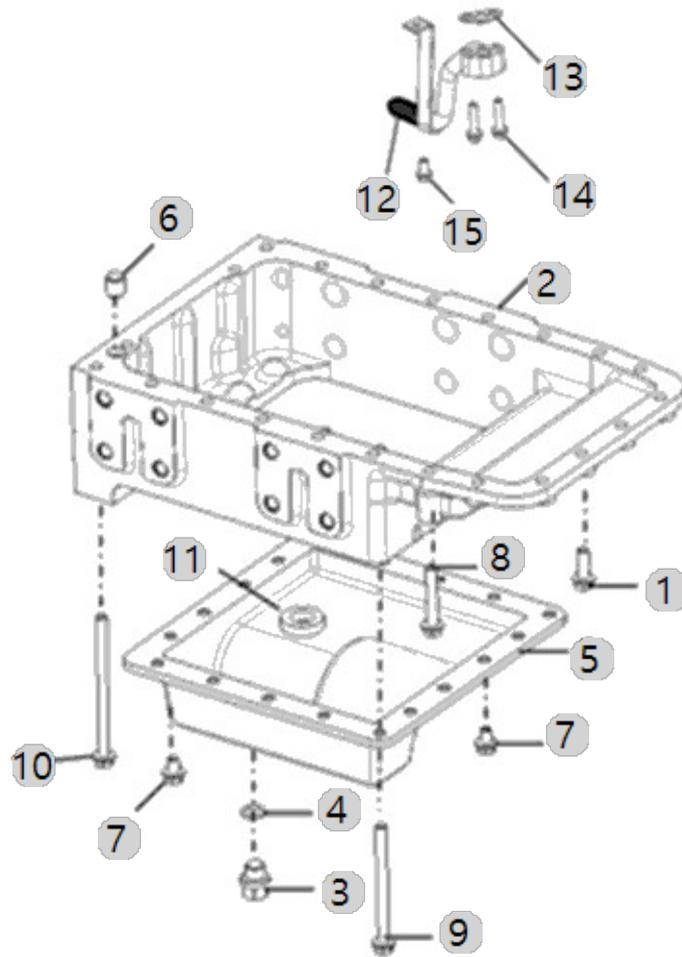



A28\_001

A1700N5-UTR\_4  
(AB00223)

PUMP, LUBRICATING OIL

Year/Month

2022-12-14

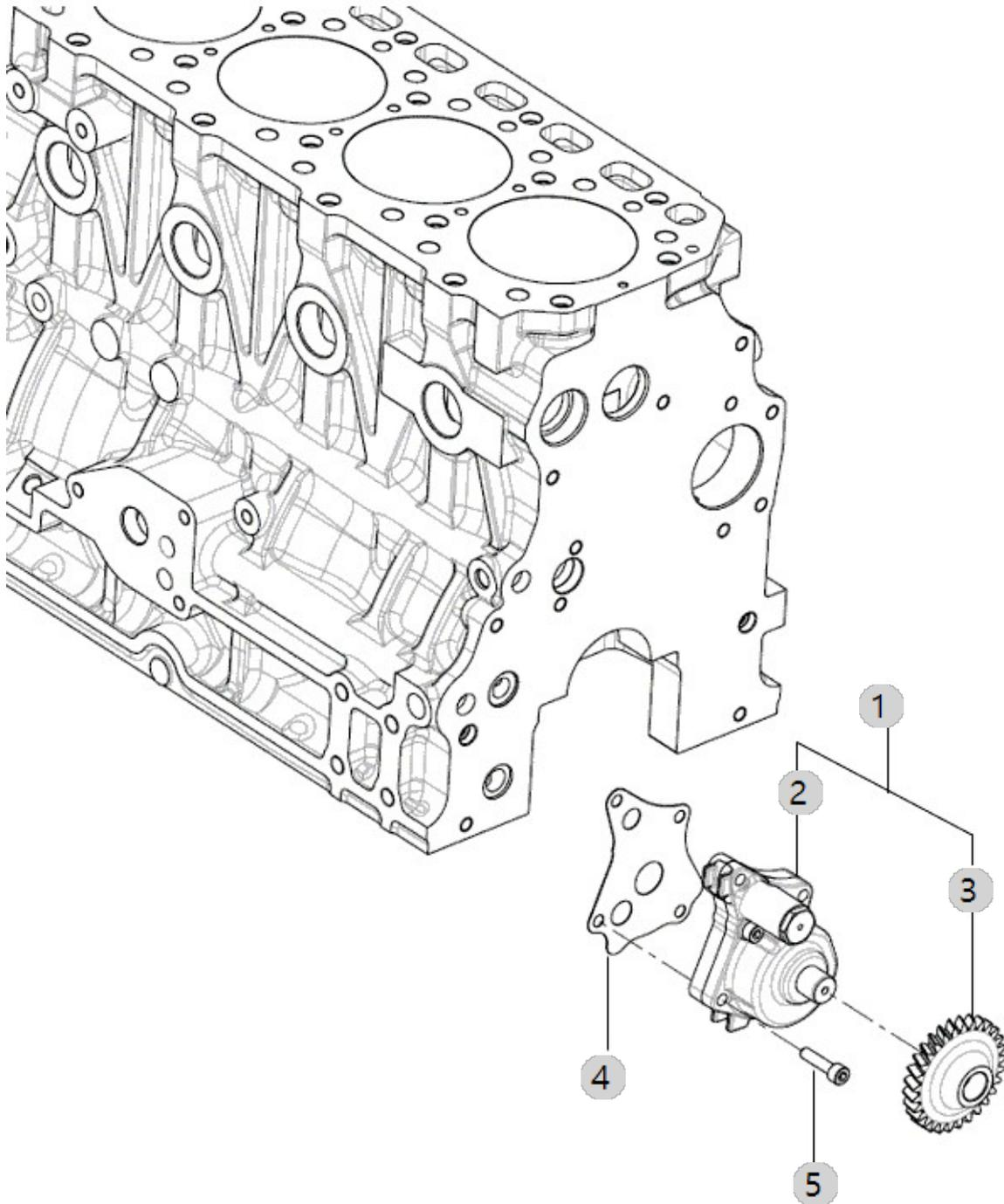



A29\_005

A1700N5-UTR\_4  
(AB00223)

FILTER, LUBRICATING OIL

Year/Month

2022-12-14

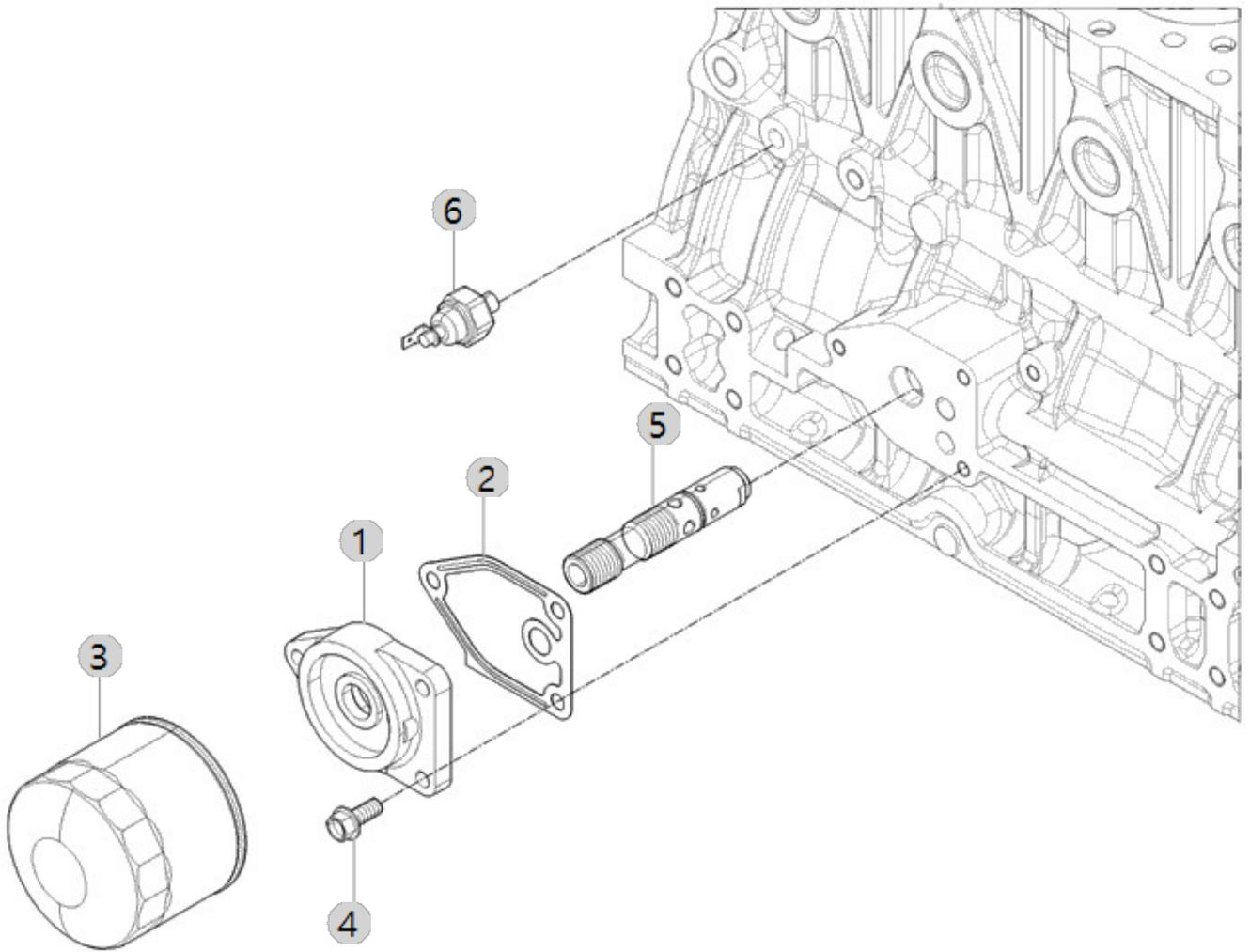



A30\_003

A1700N5-UTR\_4  
(AB00223)

FRONT GEAR ACCESSORY DRIVE

Year/Month

2022-12-14

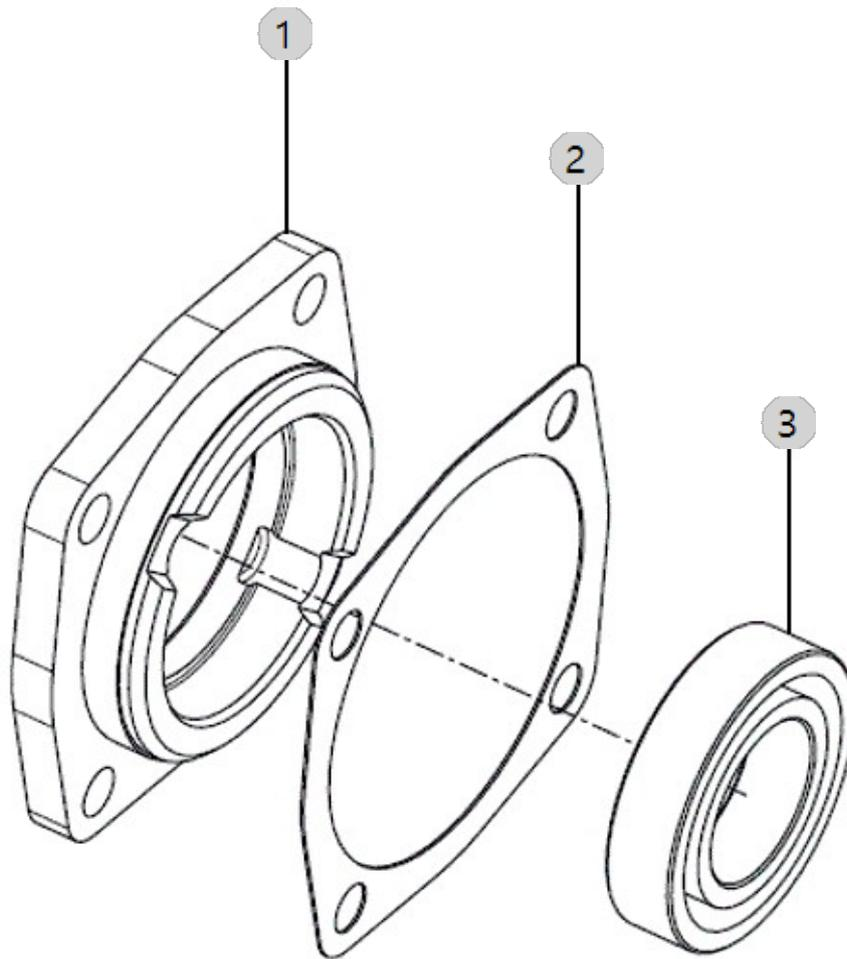





A31\_003

A1700N5-UTR\_4  
(AB00223)

# PISTON

Year/Month

2022-12-14

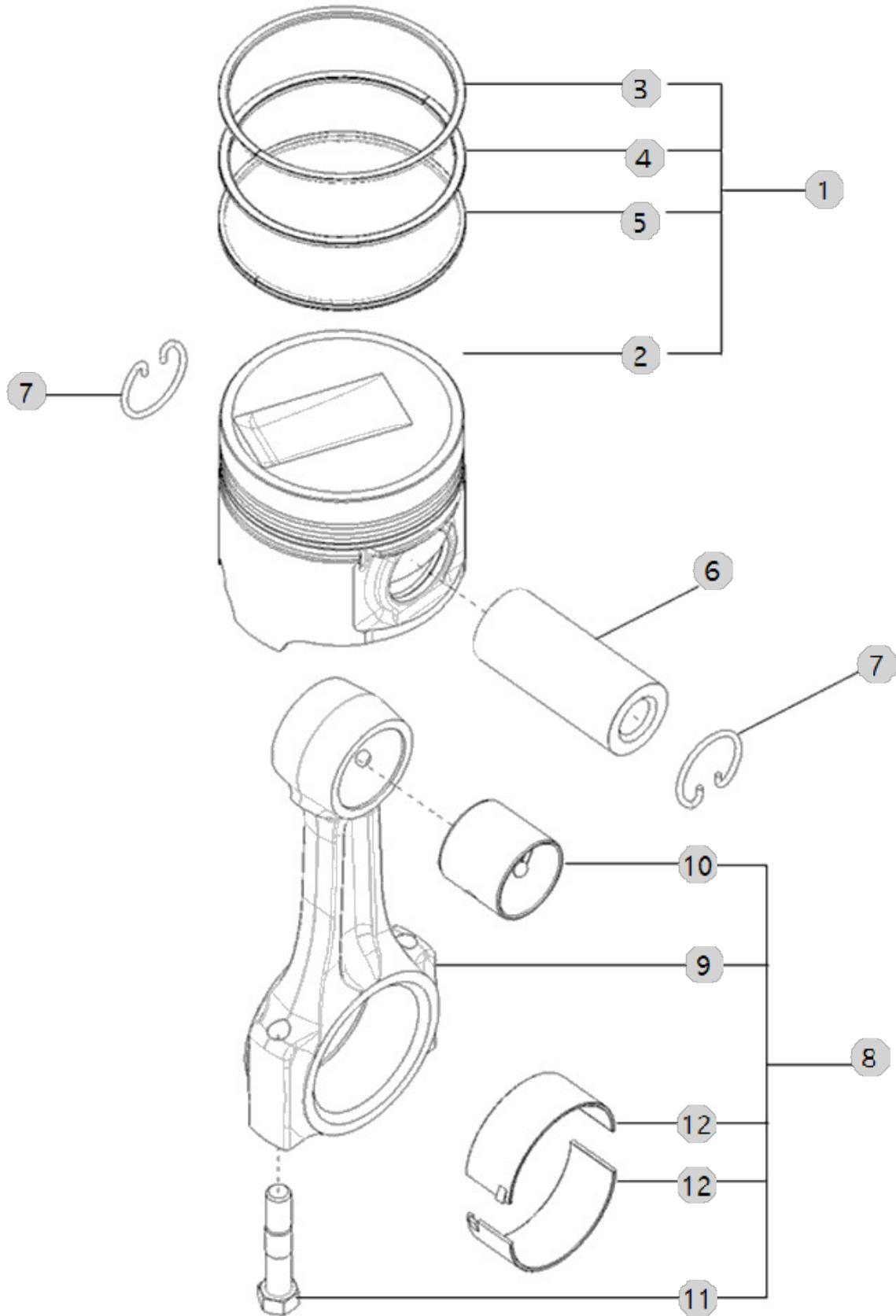



A32\_002

A1700N5-UTR\_4  
(AB00223)

LEVER, LOCKER

Year/Month

2022-12-14

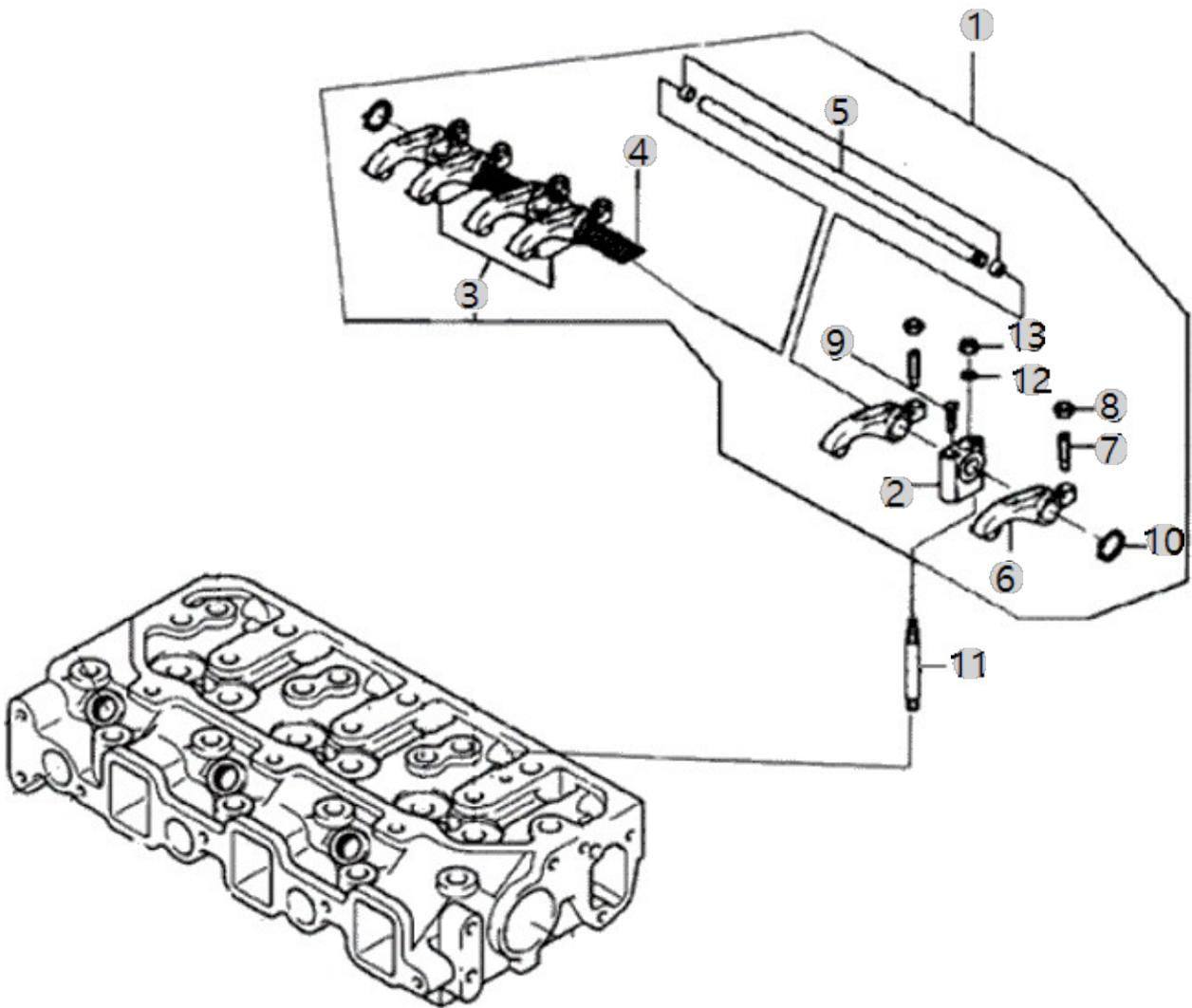



A33\_006

A1700N5-UTR\_4  
(AB00223)

# EXHAUST MANIFOLD

Year/Month

2022-12-14

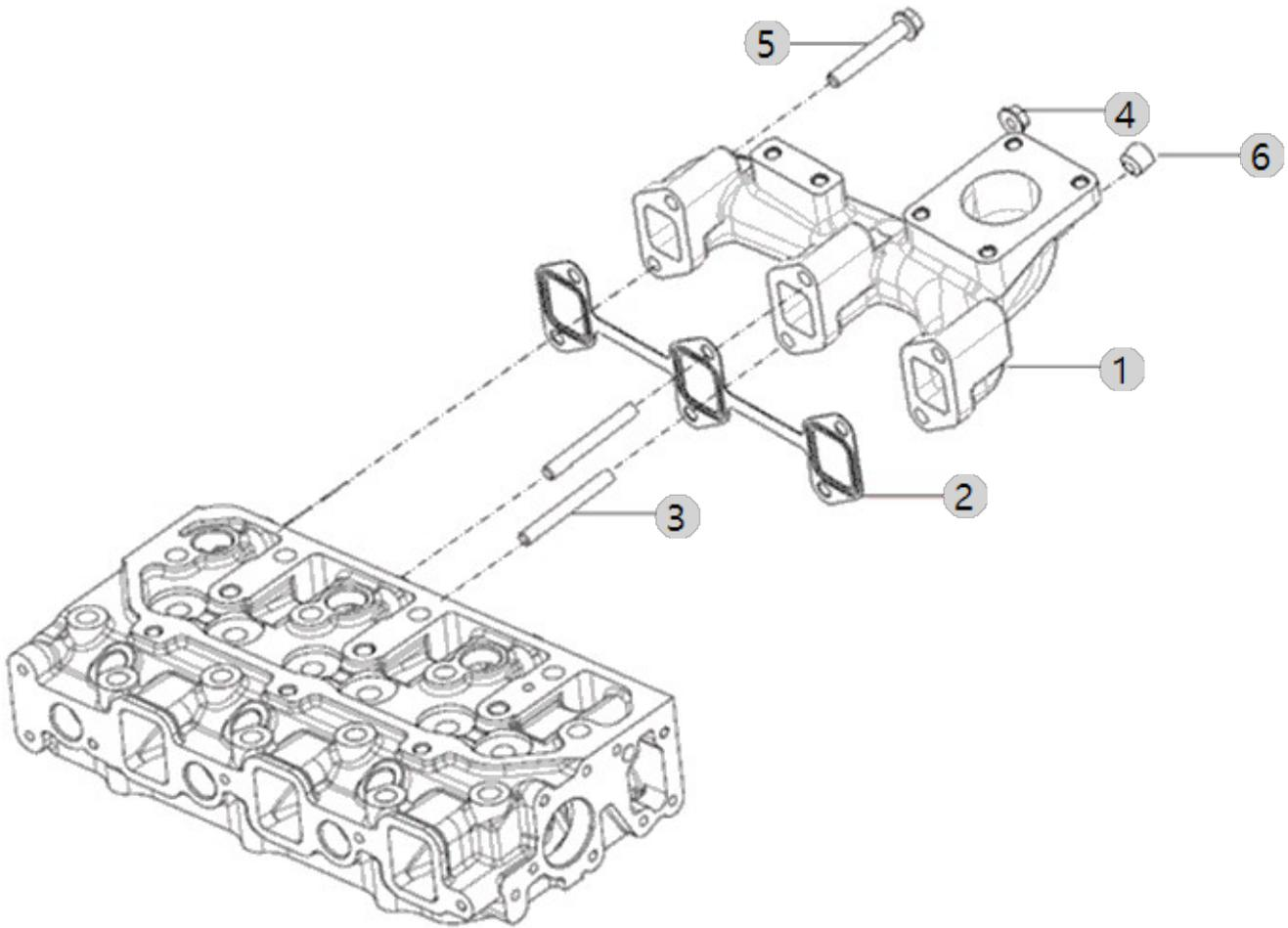



A35\_002

A1700N5-UTR\_4  
(AB00223)

# IDLE GEAR

Year/Month

2022-12-14

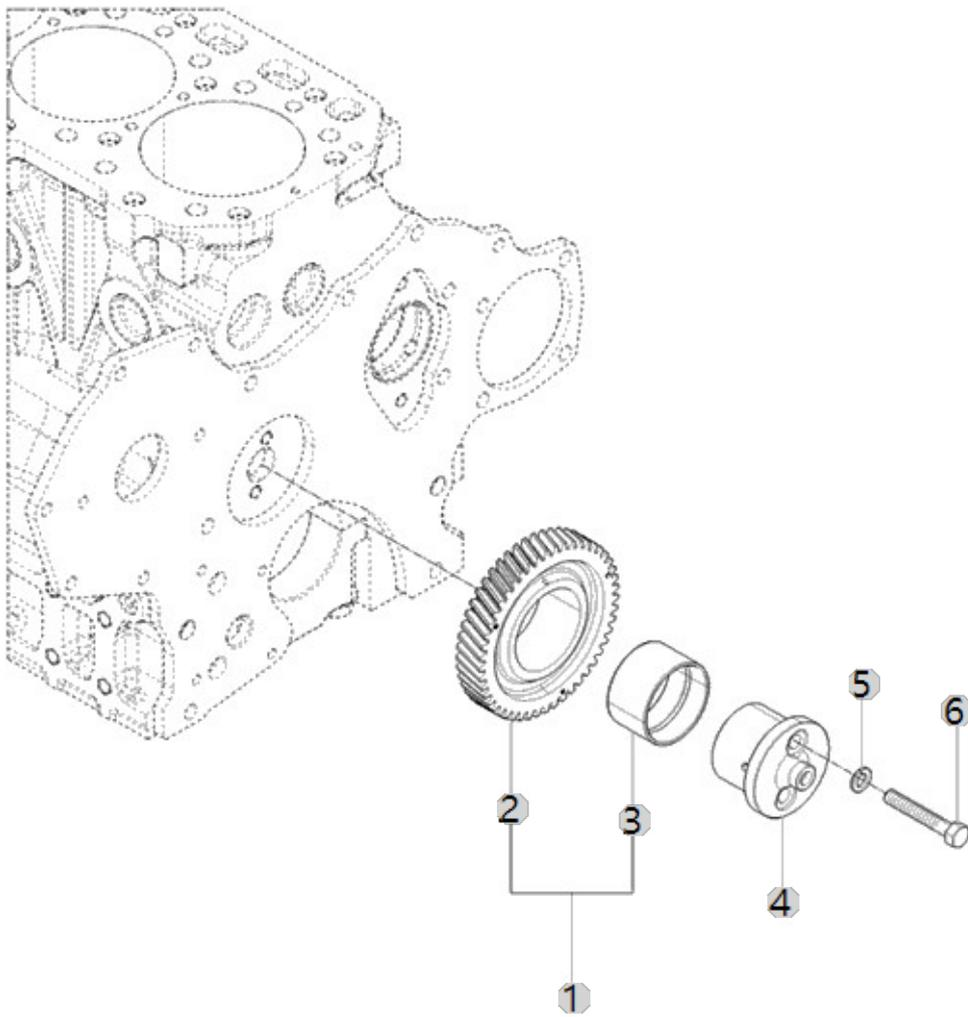





A36\_002

A1700N5-UTR\_4  
(AB00223)

### COVER, FRONT GEAR

Year/Month

2022-12-14

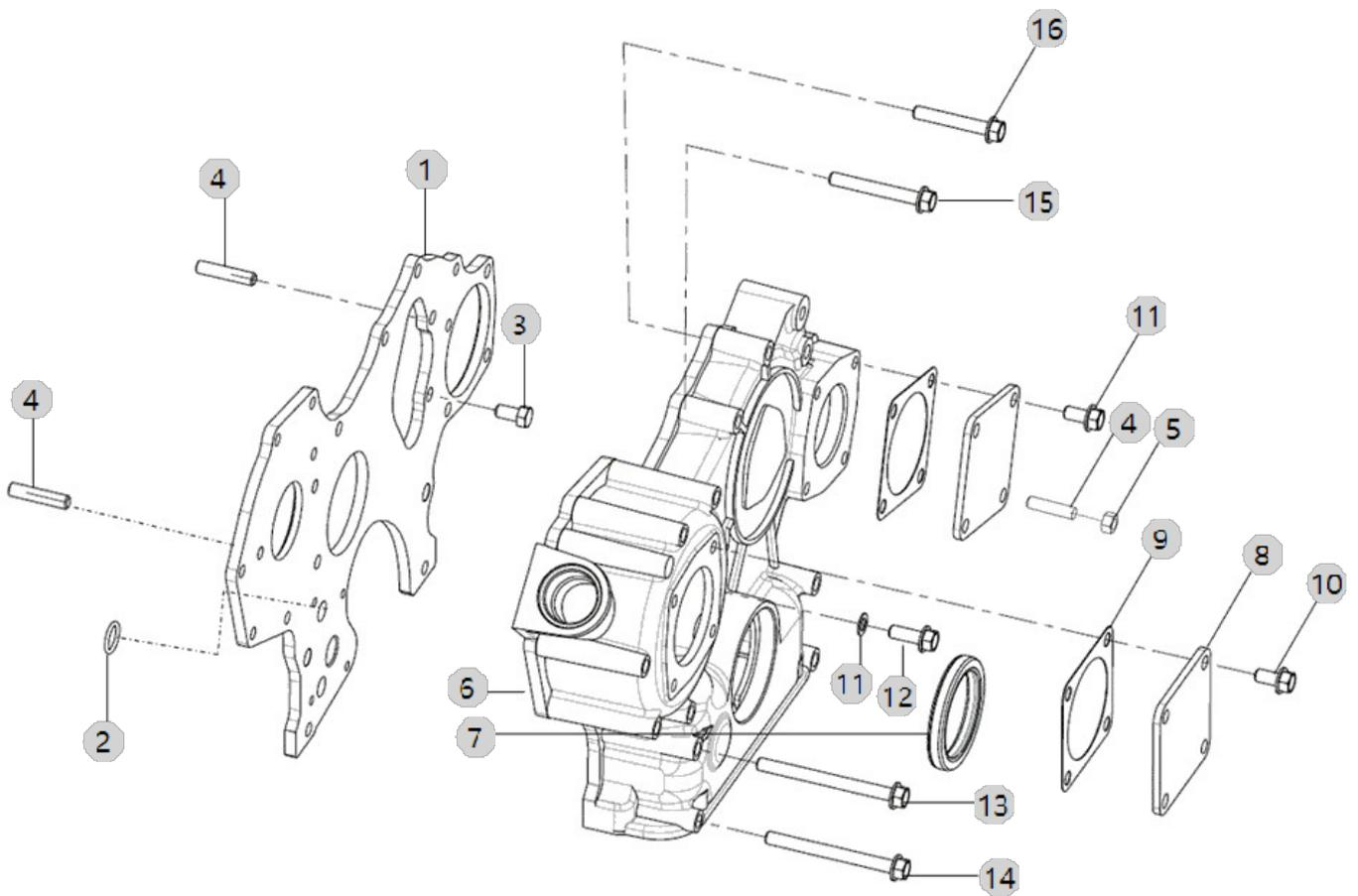



A38\_004

A1700N5-UTR\_4  
(AB00223)

GAUGE, OIL LEVEL

Year/Month

2022-12-14

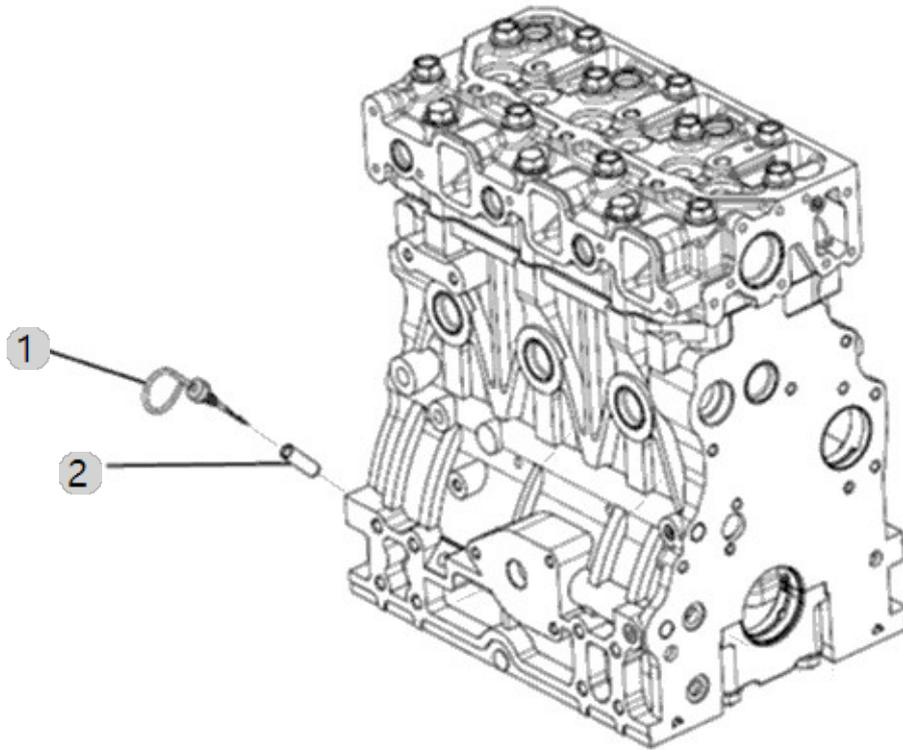



A39\_001

A1700N5-UTR\_4  
(AB00223)

### OIL FILLER CAP

Year/Month

2022-12-14

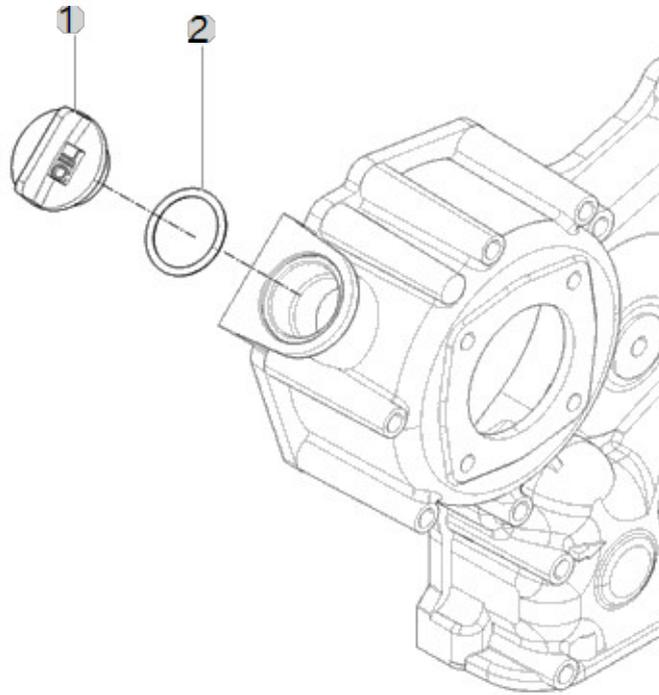



A40\_003

A1700N5-UTR\_4  
(AB00223)

LIFT ASS'Y OPTION

Year/Month

2022-12-14

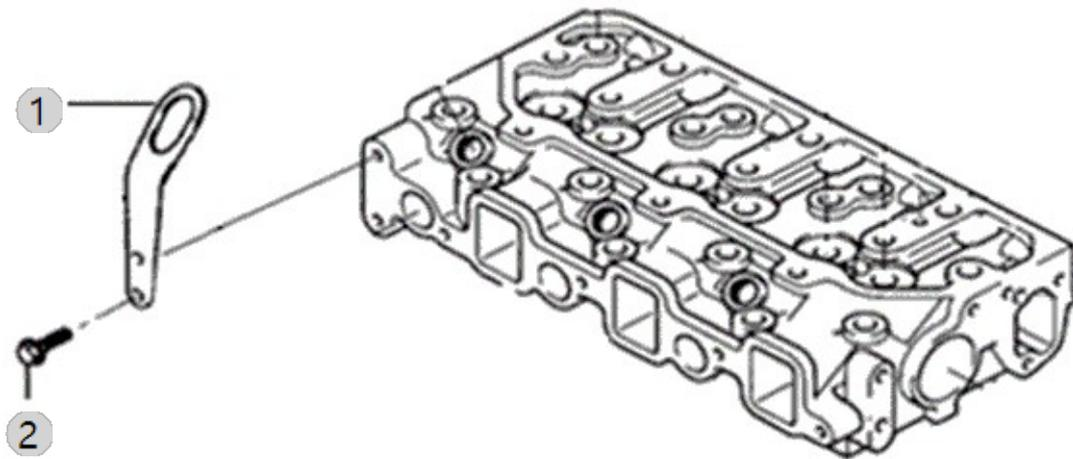





A42\_003

A1700N5-UTR\_4  
(AB00223)

### MOTER, STARTIONS

Year/Month

2022-12-14

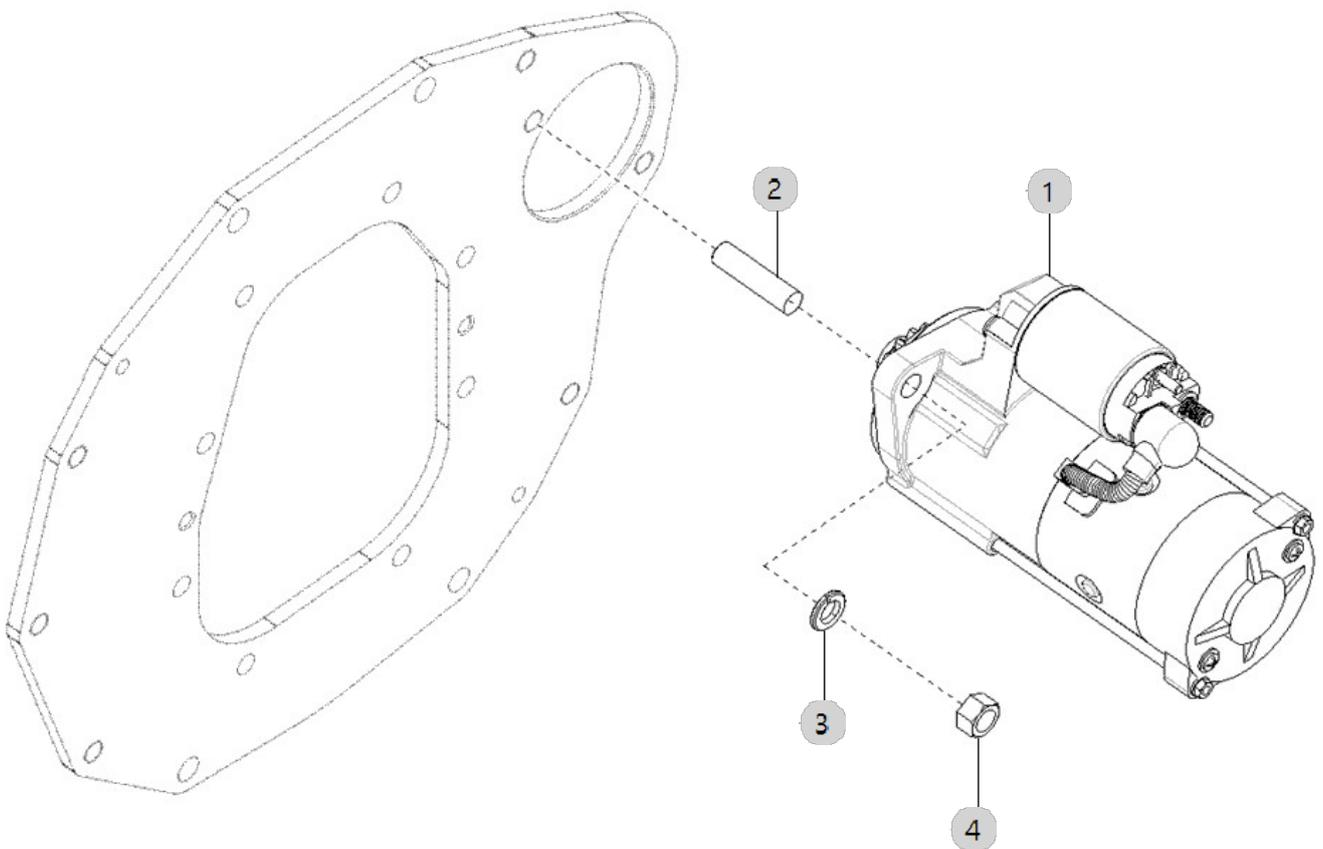



A43\_001

A1700N5-UTR\_4  
(AB00223)

DPF SUPPORT OPTION

Year/Month

2022-12-14

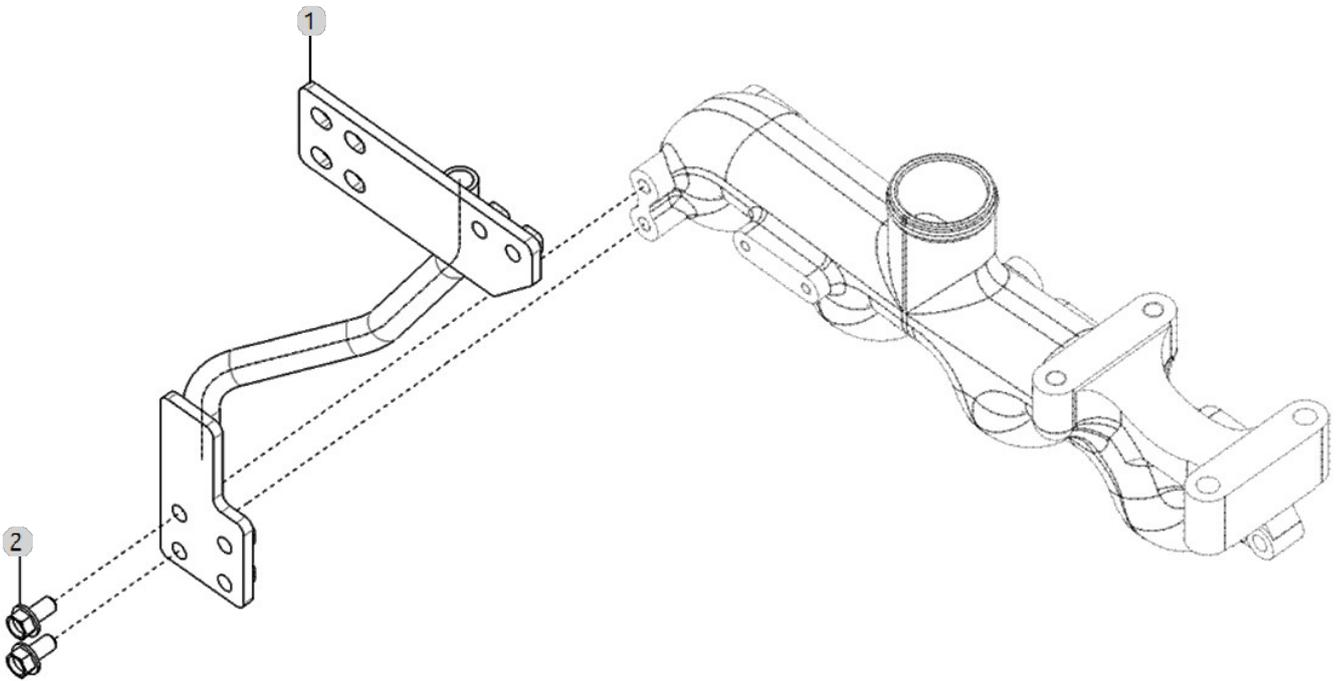



A44\_003

A1700N5-UTR\_4  
(AB00223)

### DPF MOUNTING OPTION

Year/Month

2022-12-14

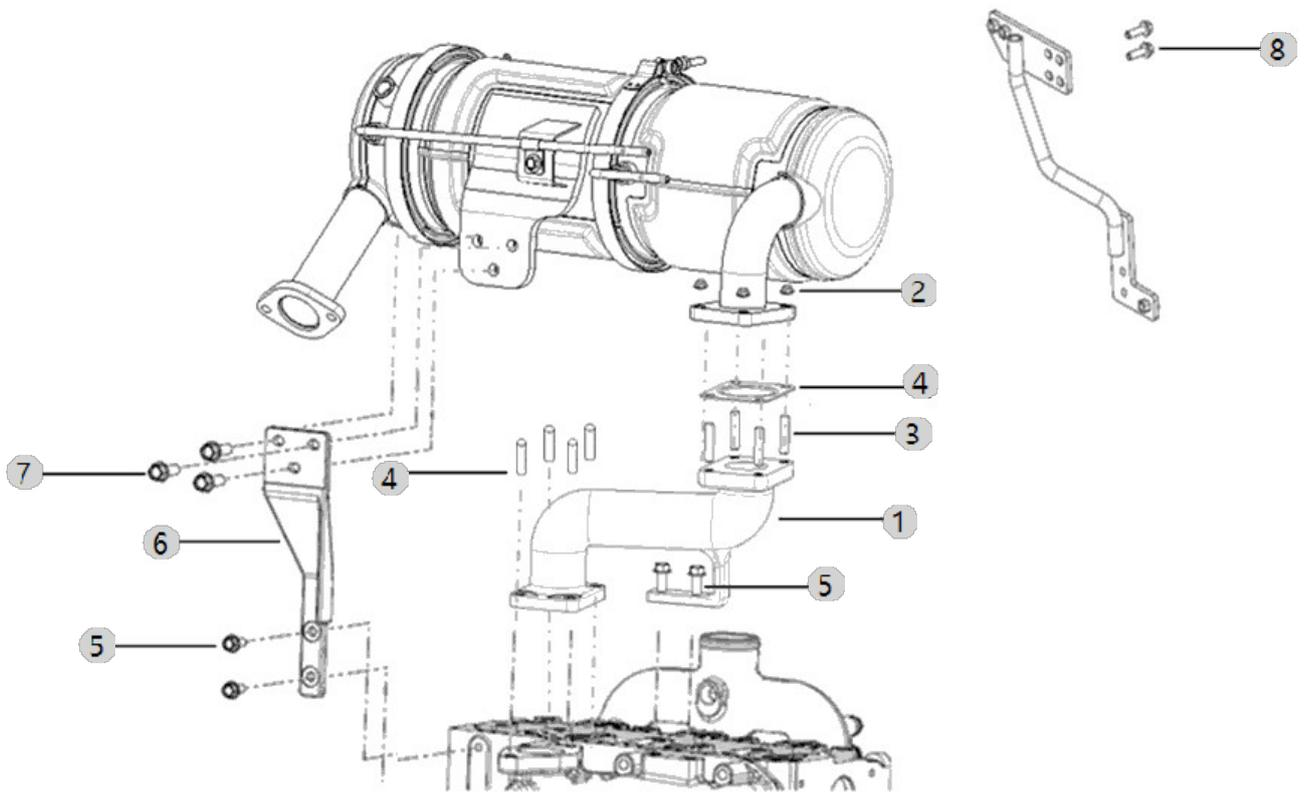



A45\_011

A1700N5-UTR\_4  
(AB00223)

DPF

Year/Month

2022-12-14

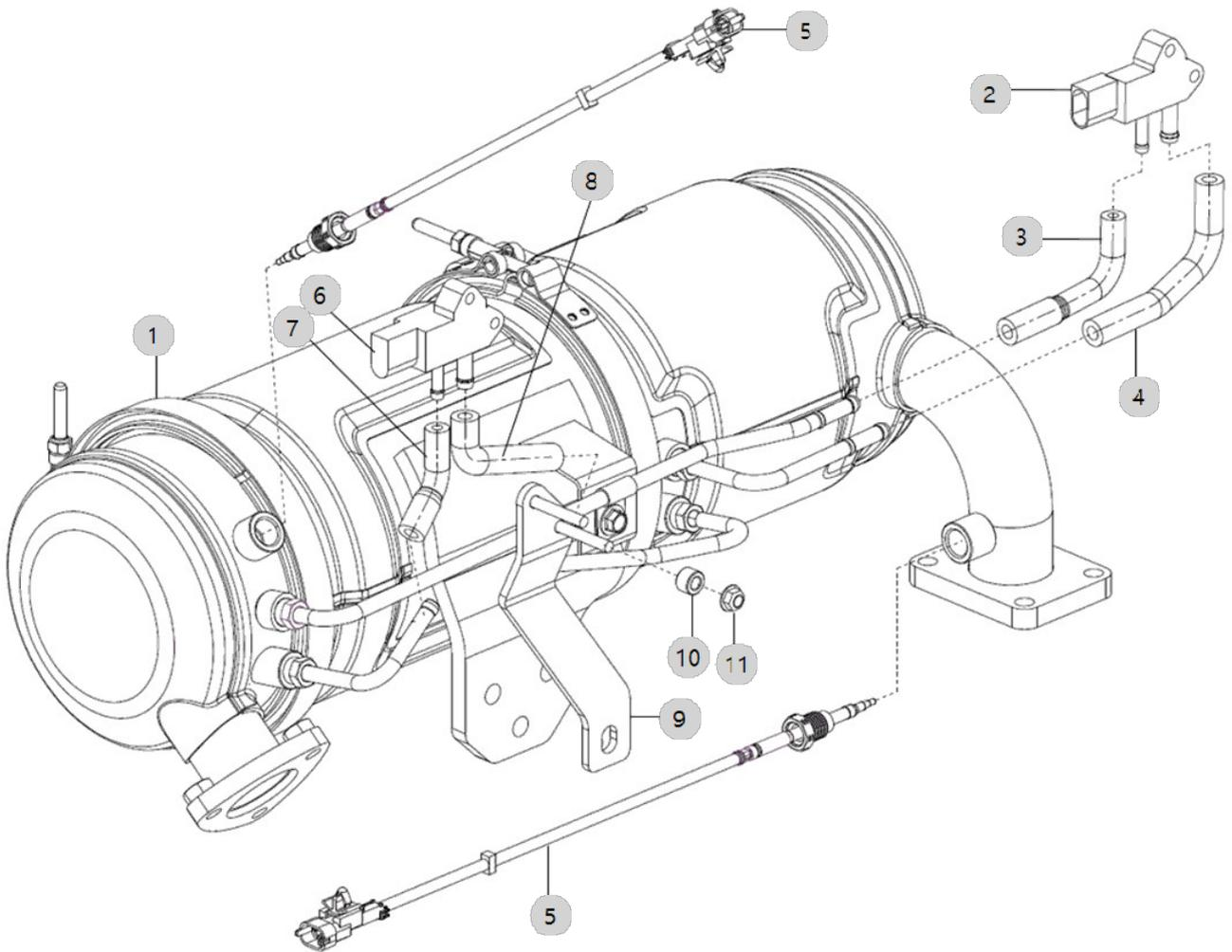





A48\_006

A1700N5-UTR\_4  
(AB00223)

V-BELT

Year/Month

2022-12-14

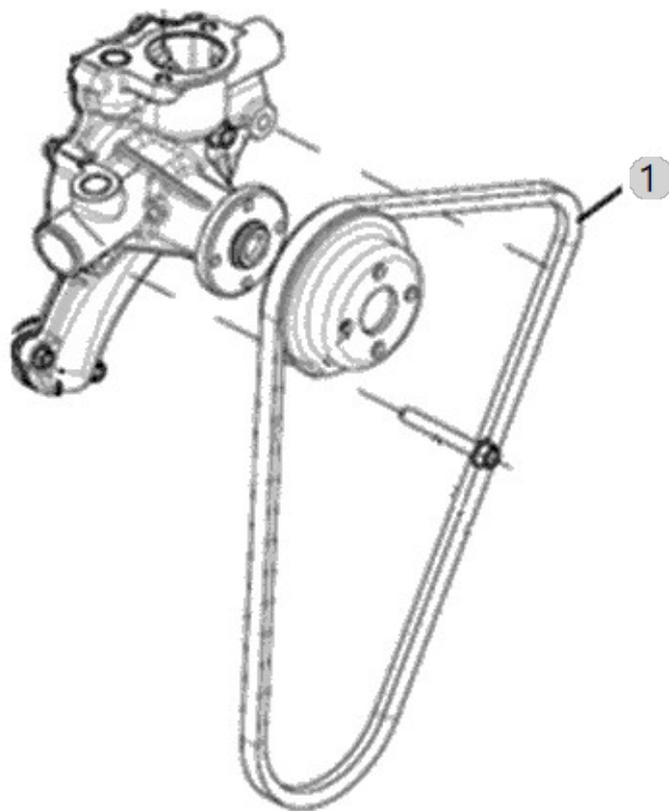



B01010

3015R\_US\_FL  
(AC02154)

(FUEL TANK)

Year/Month

2022-12-14

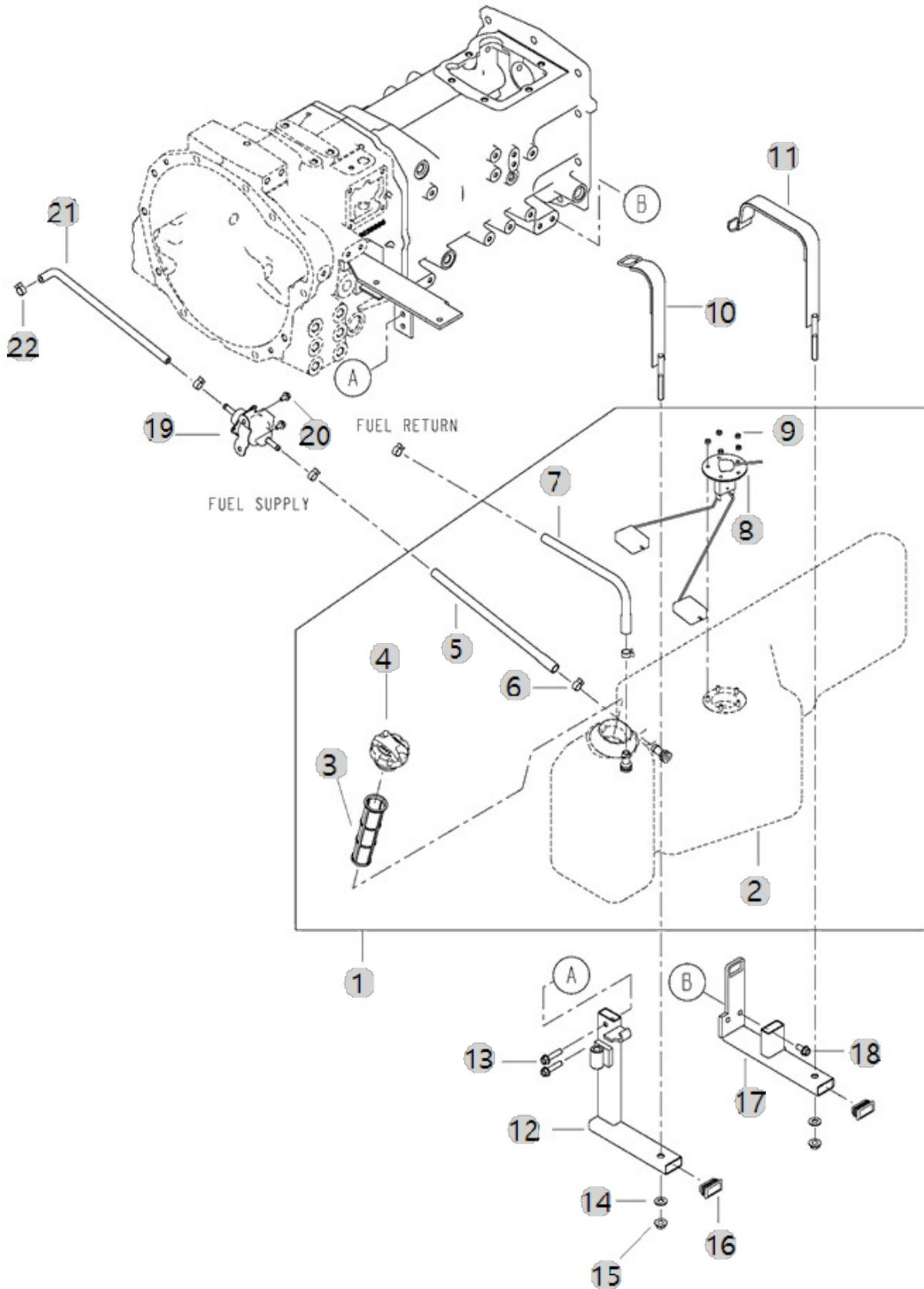







B03010

3015R\_US\_FL  
(AC02154)

(AIR CLEANER)

Year/Month

2022-12-14

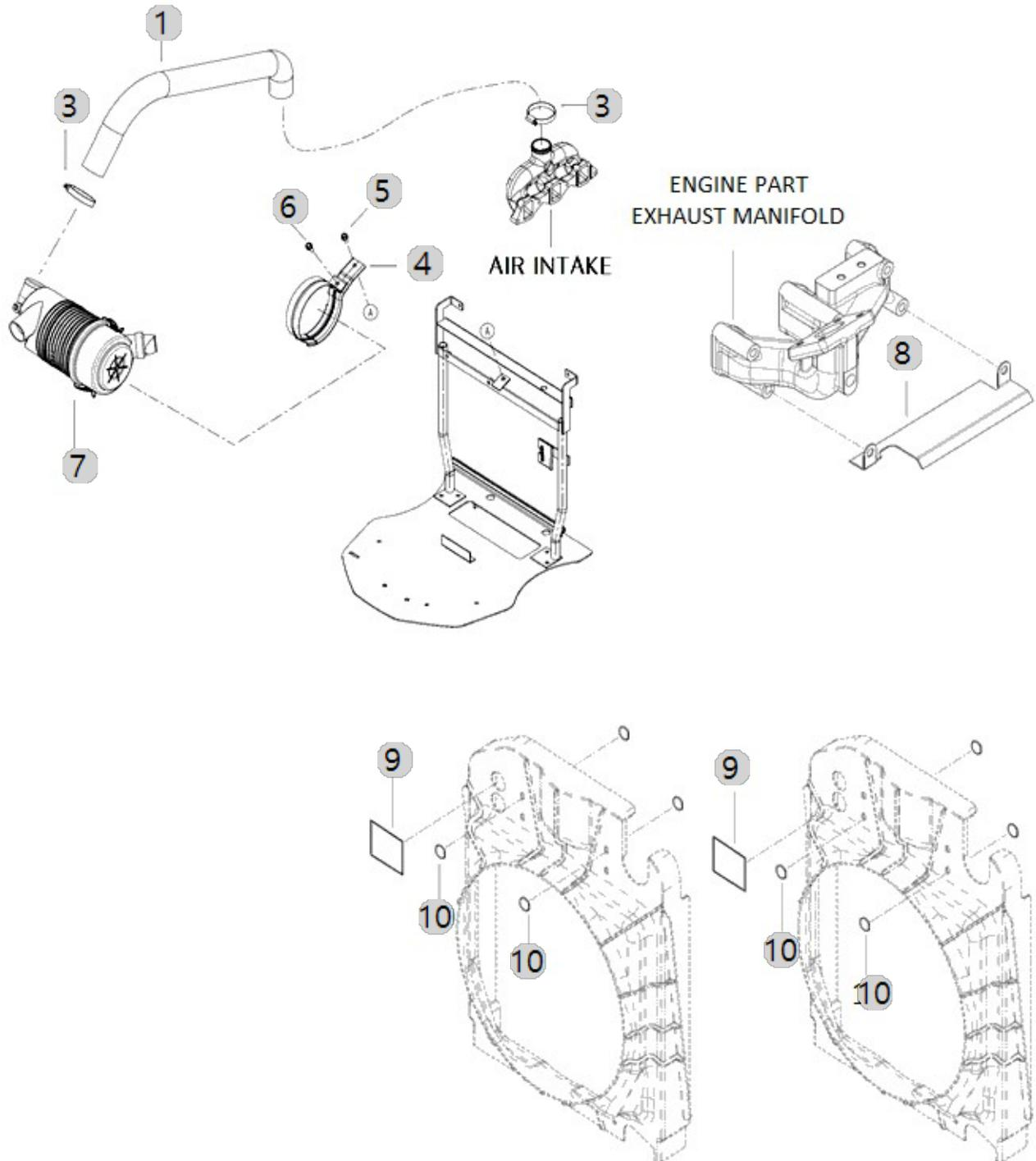





B05011

3015R\_US\_FL  
(AC02154)

(LEVER ACCELERATOR)

Year/Month

2022-12-14

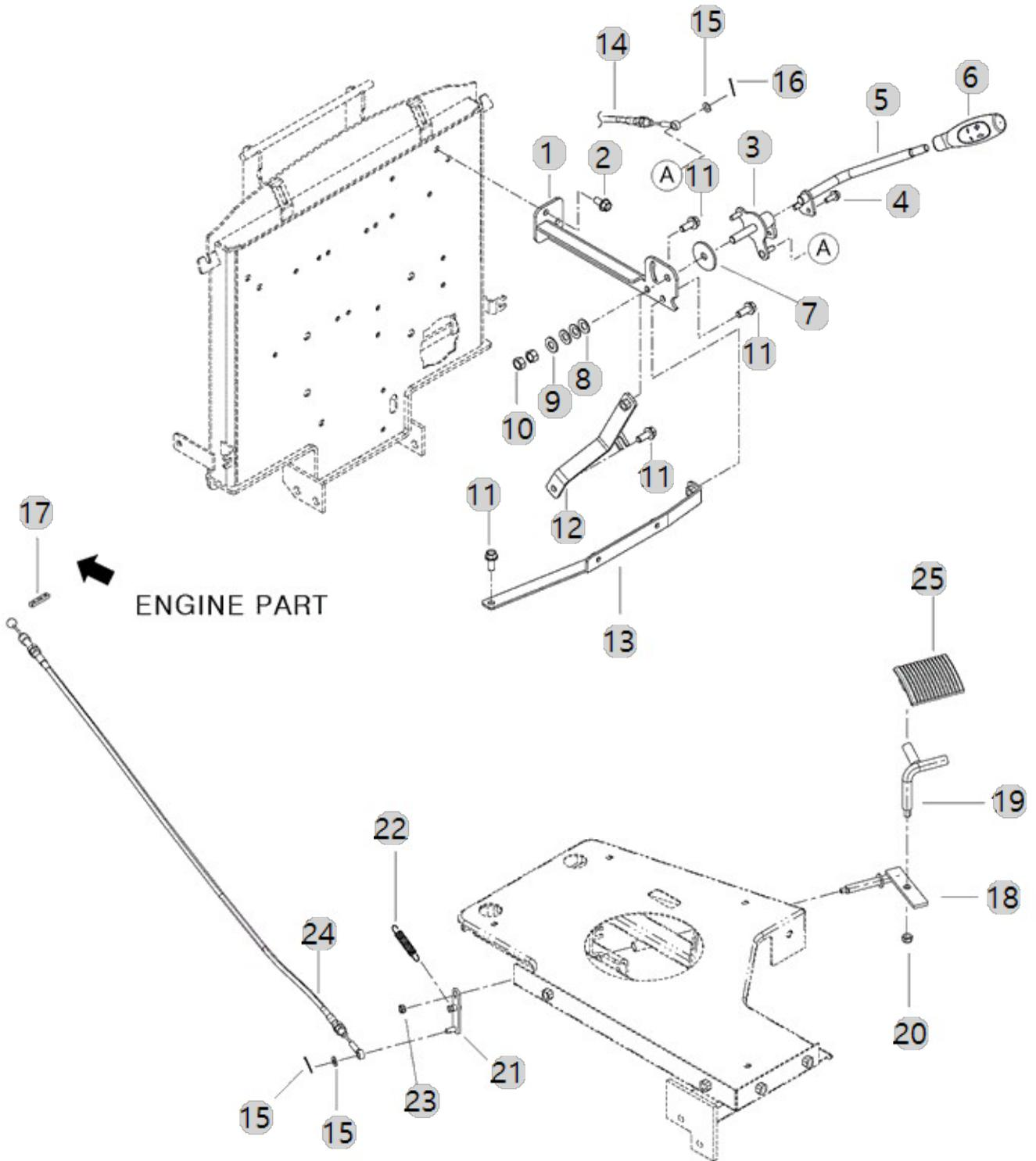



C02010-B

3015R\_US\_FL  
(AC02154)

(BRAKE PEDAL)

Year/Month

2022-12-14

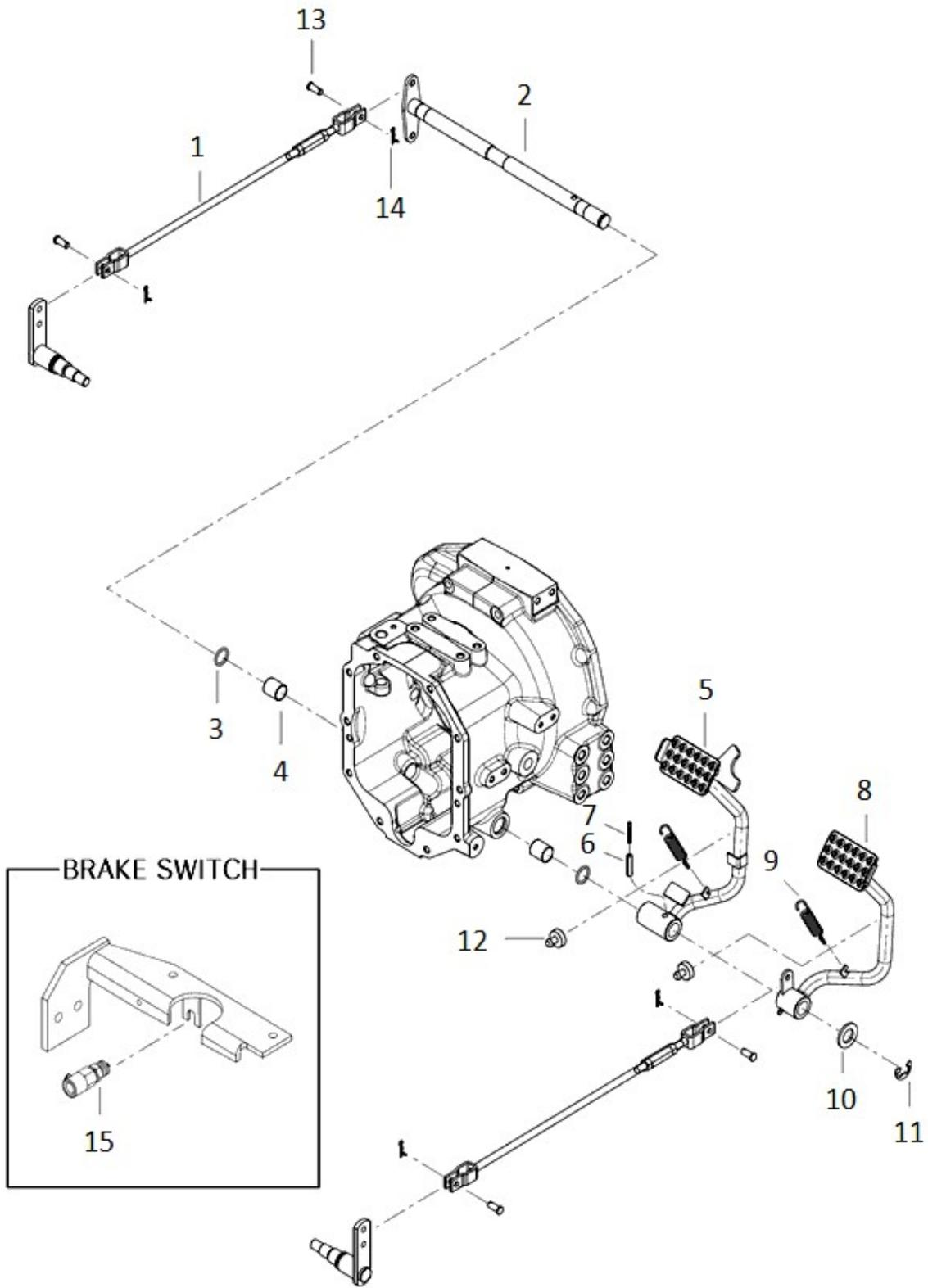



C02050

3015R\_US\_FL  
(AC02154)

(PARKING BRAKE)

Year/Month

2022-12-14

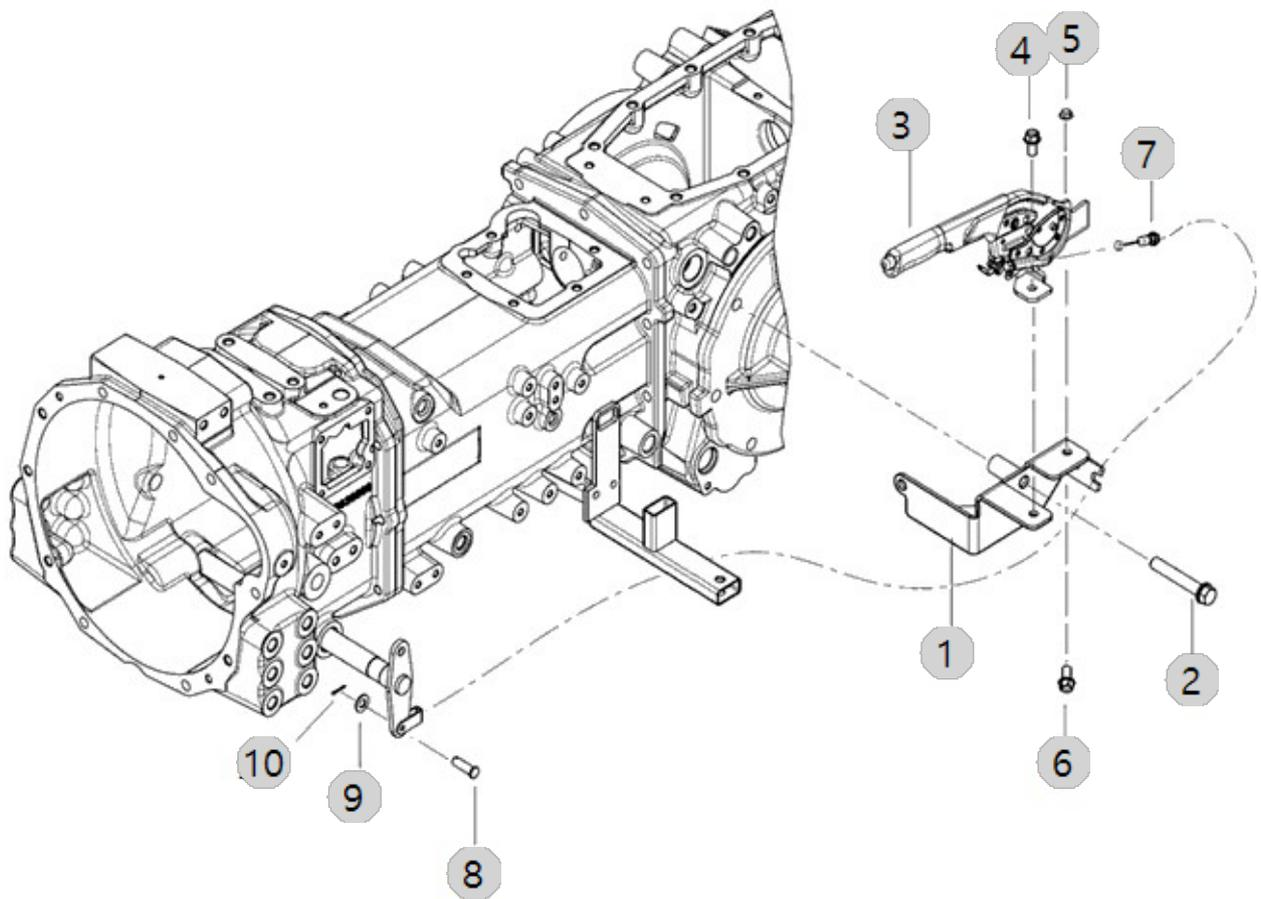



C04010

3015R\_US\_FL  
(AC02154)

(SHUTTLE ASS'Y)

Year/Month

2022-12-14

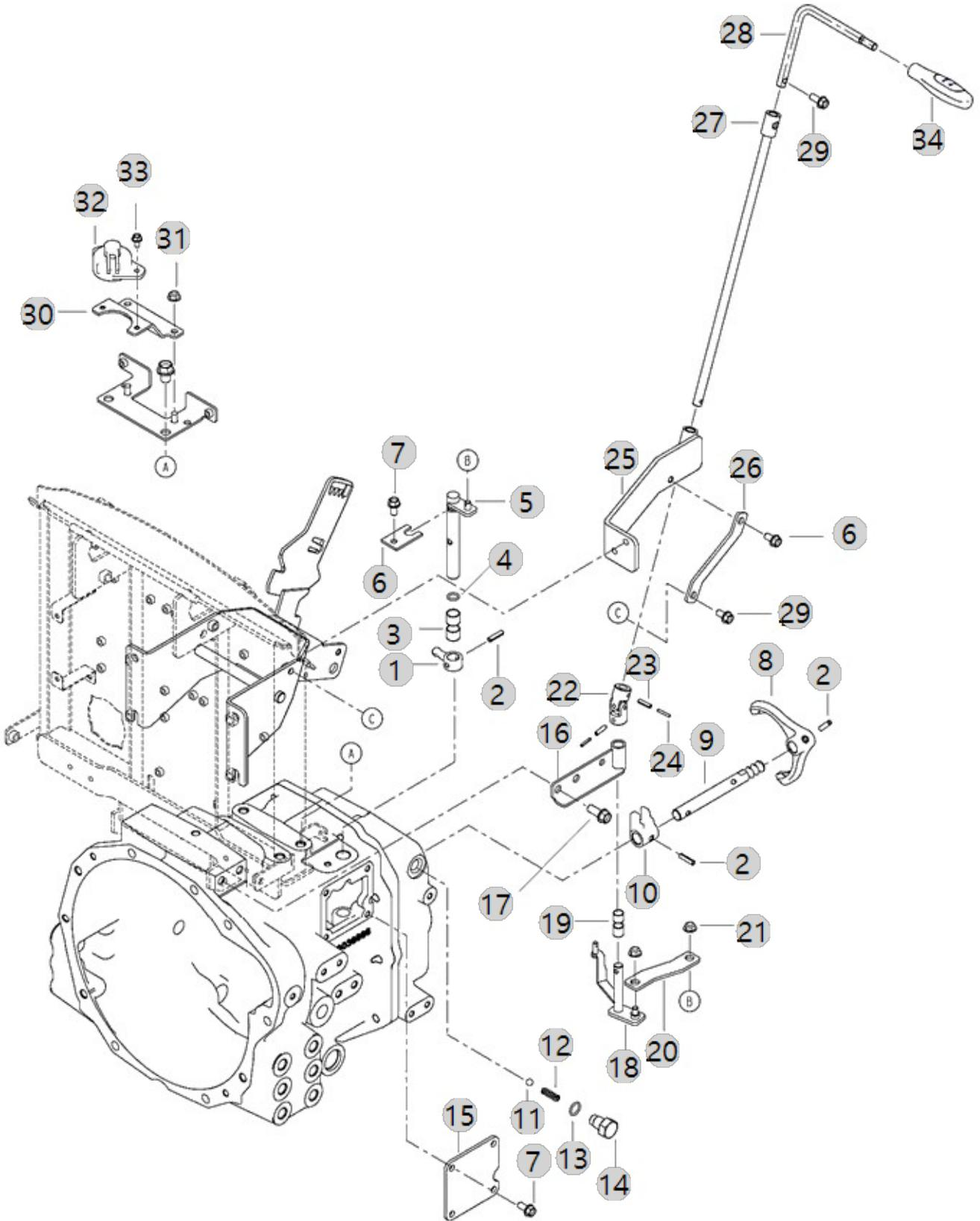



C04010		(SHUTTLE ASS'Y)				Year/Month
3015R_US_FL (AC02154)						2022-12-14
순번 (NO)	부품번호 (PART NO)	품명 (PART NAME)	품명 (PART NAME)	수량 (QTY)	규격 (SPEC)	비고 (REMARK)
1	TA00038532A	주변속암	ARM-M/SHIFT	1		
2	22351-060025	SPRINGPIN6X25	PIN, SPRING (6-25)	3	D6X25	
3	24550-016150	드라이부시	DRYBUSH	2		
4	24311-000120	O-링 495-12	O-RING, DYNAMIC (Φ12)	1	P12	
5	TA00065140B	셔틀 축 조합	ASSY, SHUTTLE SHAFT	1		
6	TA00039028A	플레이트	PLATE	1		
7	26106-080162	플랜지볼트8X16	SCREW,HEXFLANGEHEADCAP	6	M8XP1.25X16	
8	TA00038785A	셔틀 포크	FORK, SHUTTLE	1		
9	TA00038503B	전후진포크축	SHAFT, F/R	1		
9	TA00038503A	전후진포크축	SHAFT, F/R	1		
10	TA00038399A	셔틀 시프터	SHIFTER, SHUTTLE	1		
11	24190-110001	강구11/32	Ball, Steel (11/32)	1	11/32	
12	TA00038502A	스프링	SPRING	1		
13	24311-000150	O-링(P형)	O-RING, DYNAMIC (Φ15)	1	P15	
14	TA00038524F	볼트	BOLT	1		
15	TA00039099B	셔틀 커버	COVER	1		
16	TA00065177B	셔틀 링크 브래킷	BRACKET, SHUTTLE LINK	1		
16	TA00065177D	셔틀 링크 브래킷	BRACKET, SHUTTLE LINK	1		
17	26106-100202	육각플랜지볼트	HEX BOLT, (10-20)	2	M10XP1.5X20	
18	TA00065142C	셔틀 링크 C	LINK, SHUTTLE C	1		
18	TA00065142B	셔틀 링크 C	LINK, SHUTTLE C	1		
18	TA00065142A	셔틀 링크 C	LINK, SHUTTLE C	1		
19	24550-012150	드라이부시	BUSH	4	12X15	
20	TA00065141B	연결 플레이트	PLATE	1		
21	26367-080002	259, 육각플랜지너트	HEX FLANGE NUT (Φ8)	4	M8XP1.25	
22	TA00060736A	조인트	JOINT	1		
23	22351-050020	스프링핀5X20	PIN, SPRING (5-20)	1	D5X20	
24	22351-030020	스프링핀3X20	PIN, SPRING (3X20)	1	D3X20	
25	TA00069052B	셔틀레버 브래킷 조합	BRACKET ASSY, SHUTTLE LEVER	1		
25	TA00069052A	셔틀레버 브래킷 조합	BRACKET ASSY, SHUTTLE LEVER	1		
26	TA00069055A	지지 브래킷	BRACKET, SUPPORT	1		
26	TA00069055B	지지 브래킷	BRACKET, SUPPORT	1		
27	TA00069067A	셔틀로드 조합	SHUTTLE ROD ASSY	1		
28	TA00069070C	셔틀레버	SHUTTLE LEVER	1		
28	TA00069070B	셔틀레버	SHUTTLE LEVER	1		
28	TA00069070A	셔틀레버	SHUTTLE LEVER	1		
29	26106-080202	육각플랜지볼트	SQR FLANGE BOLT	2	M8XP1.25X20	
30	TA00065189B	센서 취부 브래킷	BRACKET	1		
30	TA00065189A	센서 취부 브래킷	BRACKET	1		
31	26367-080002	259, 육각플랜지너트	HEX FLANGE NUT (Φ8)	2	M8XP1.25	
32	TCD9110000D2	스위치(FR)	SWITCH(FR)	1		
32	TCD9110000C2	스위치(FR)	SWITCH(FR)	1		
33	26106-060122	육각플랜지볼트	HEX BOLT (6-12)	2	M6XP1.0X12	
34	TA00056013A	셔틀 노브 조합(복미)	KNOB (LEVER SHUTTLE)	1		

D01010-A

3015R\_US\_FL  
(AC02154)

(HYD PUMP)

Year/Month

2022-12-14

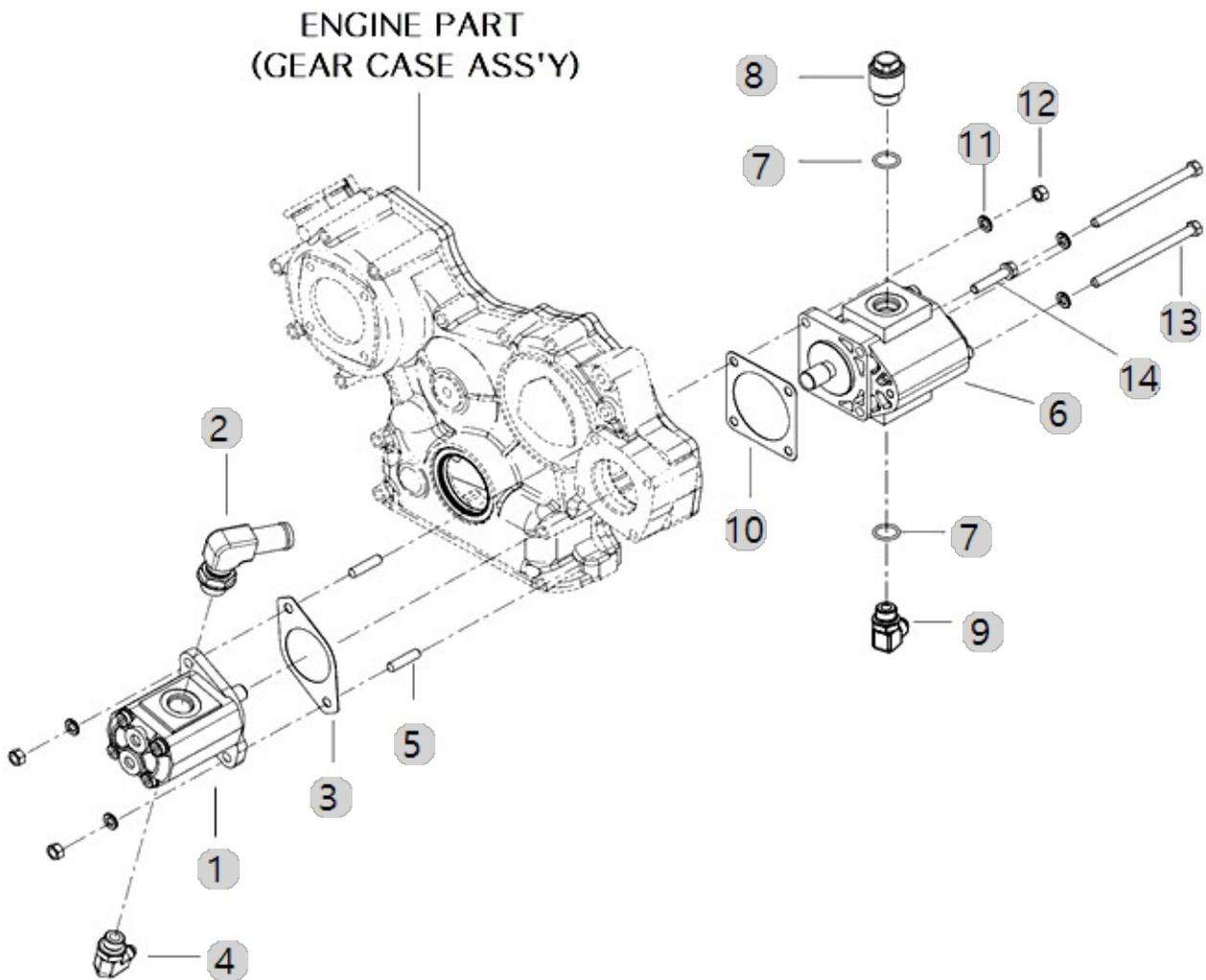



D01020-A

3015R\_US\_FL  
(AC02154)

(LOW PRESSURE PIPE)

Year/Month

2022-12-14

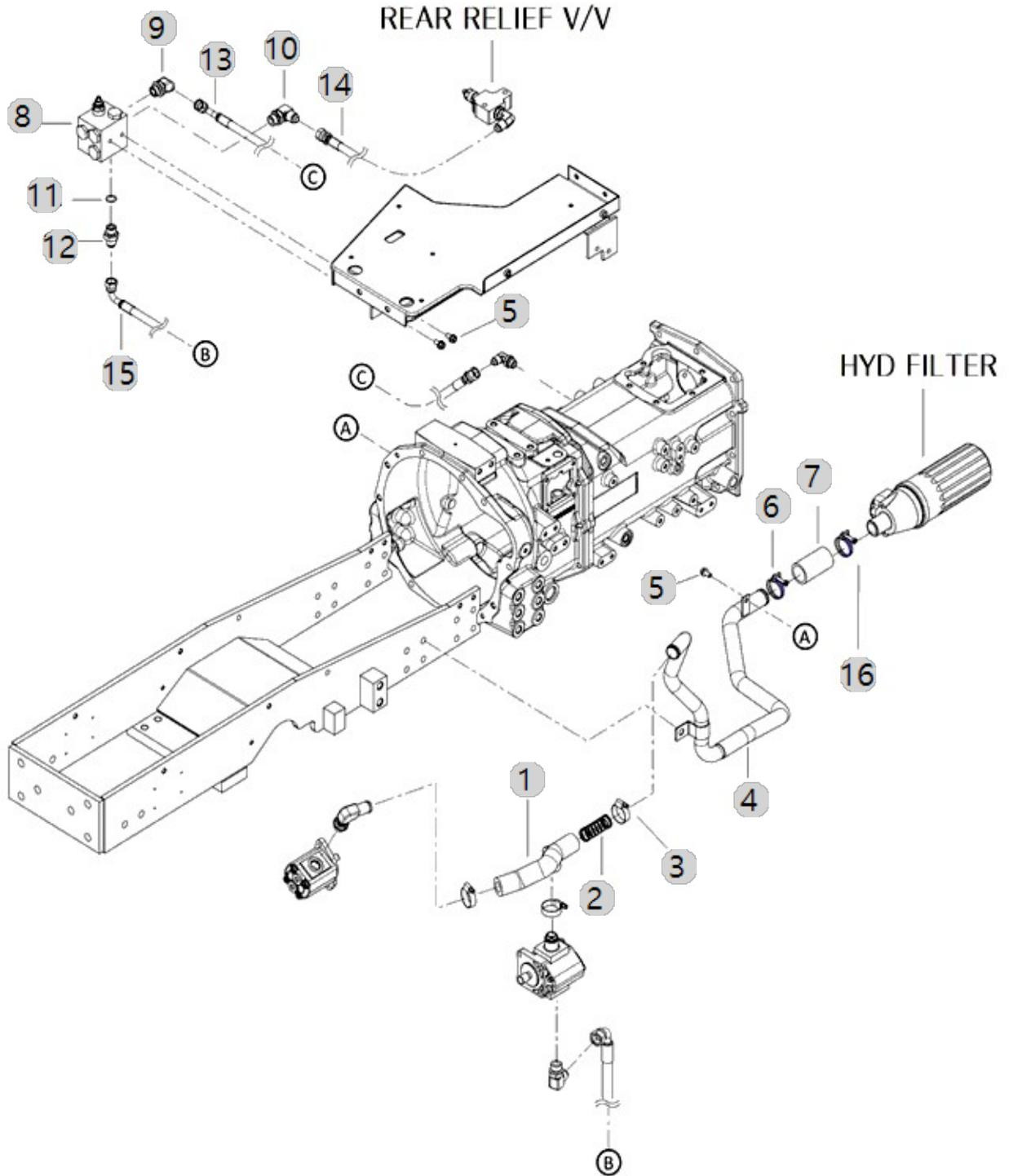



D01040

3015R\_US\_FL  
(AC02154)

(HYD FILTER)

Year/Month

2022-12-14

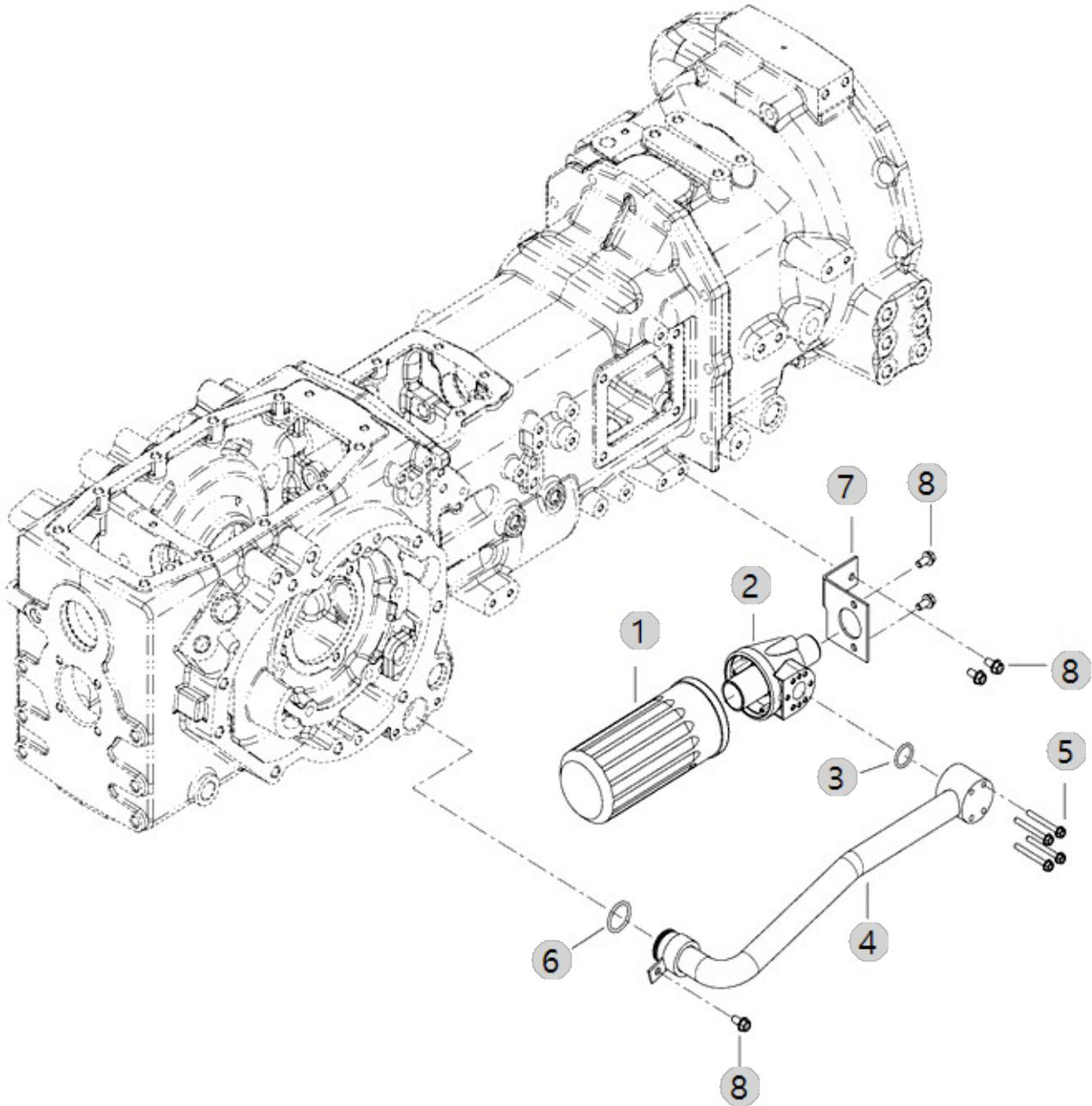



D02010

3015R\_US\_FL  
(AC02154)

(STEERING COLUMN)

Year/Month

2022-12-14

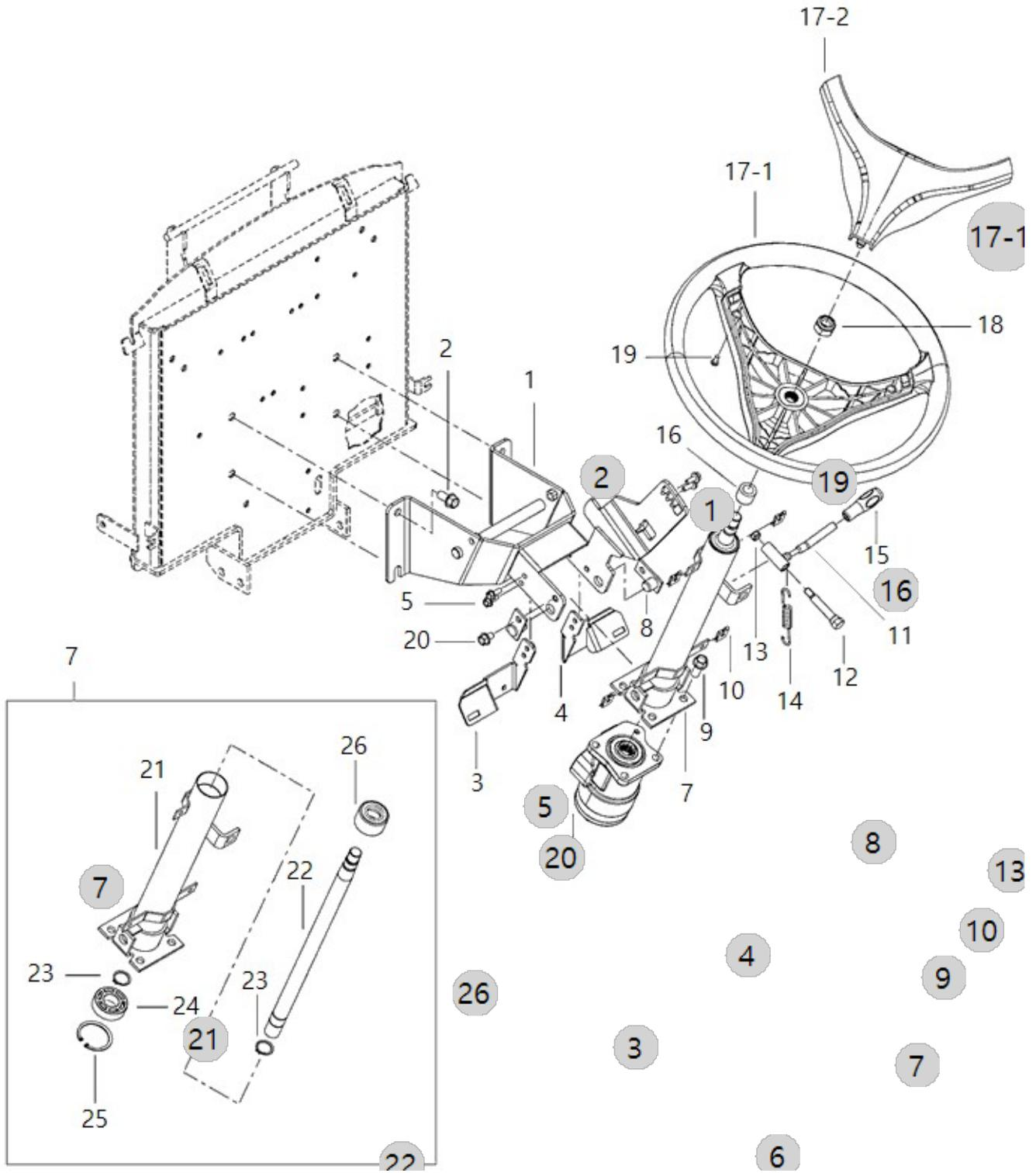





D02030

3015R\_US\_FL  
(AC02154)

(P.S.T HOSE)

Year/Month

2022-12-14

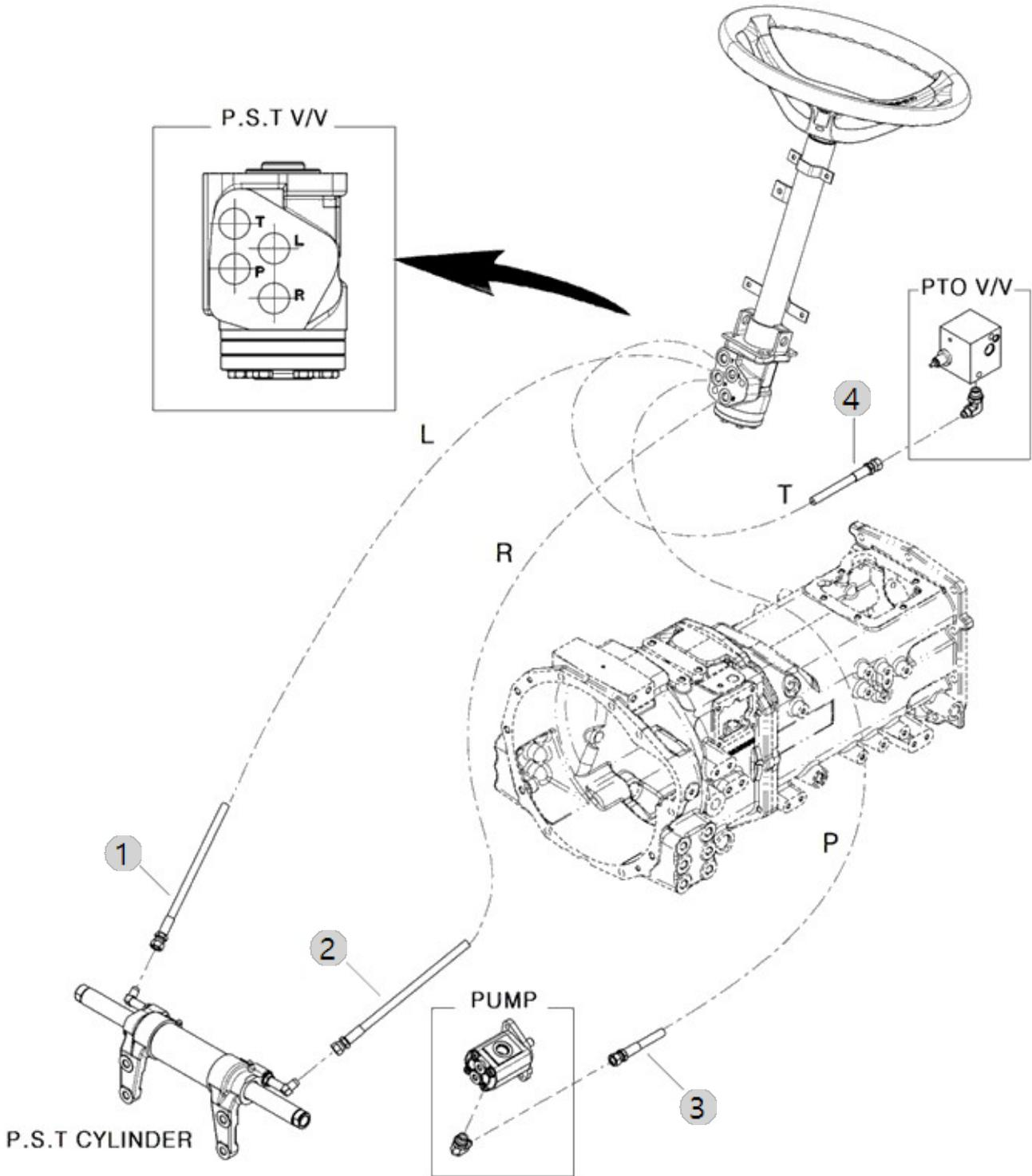



D02040

3015R\_US\_FL  
(AC02154)

(P.S.T CYLINDER)

Year/Month

2022-12-14

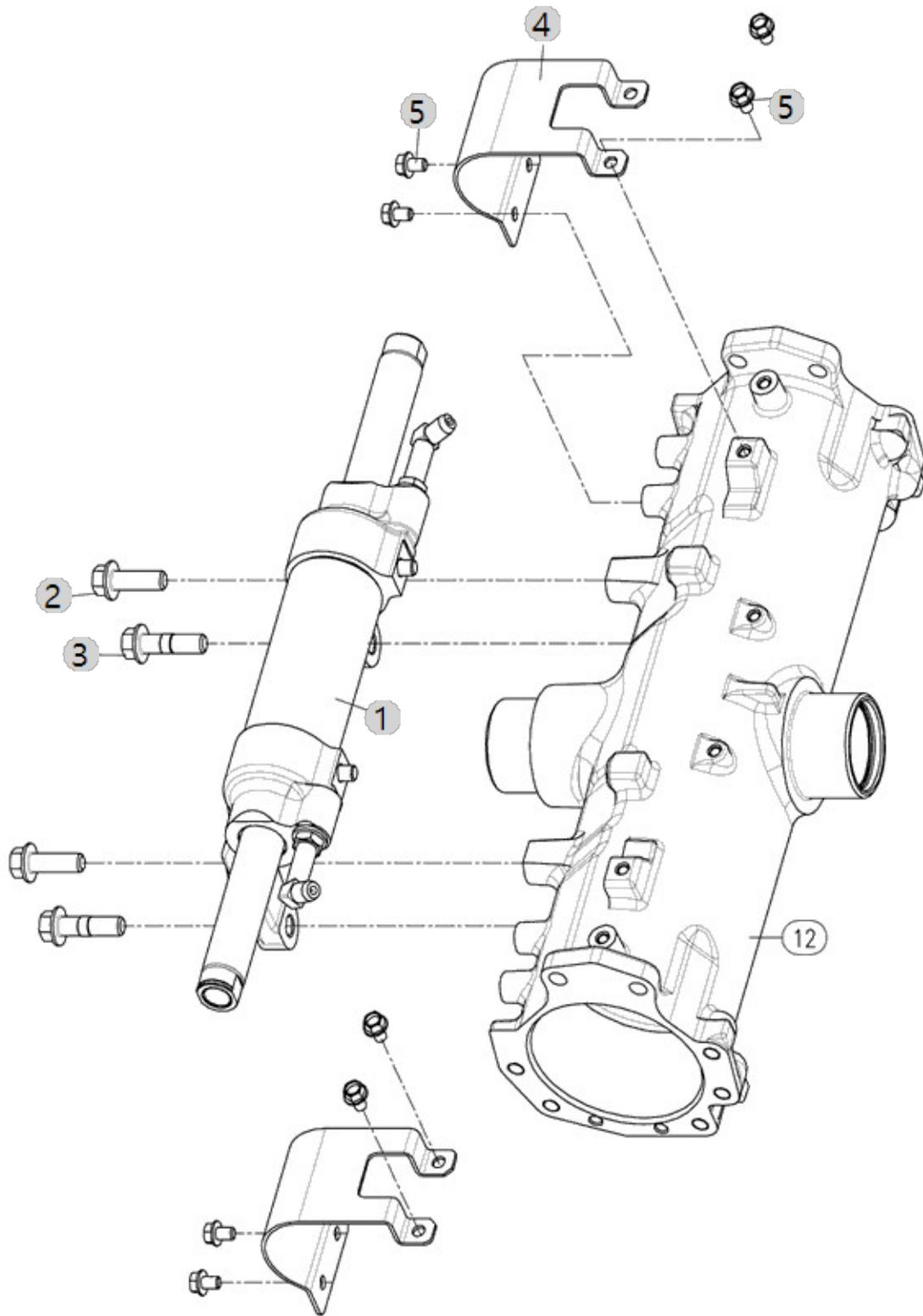



E01010

3015R\_US\_FL  
(AC02154)

(FRONT AXLE CASE)

Year/Month

2022-12-14

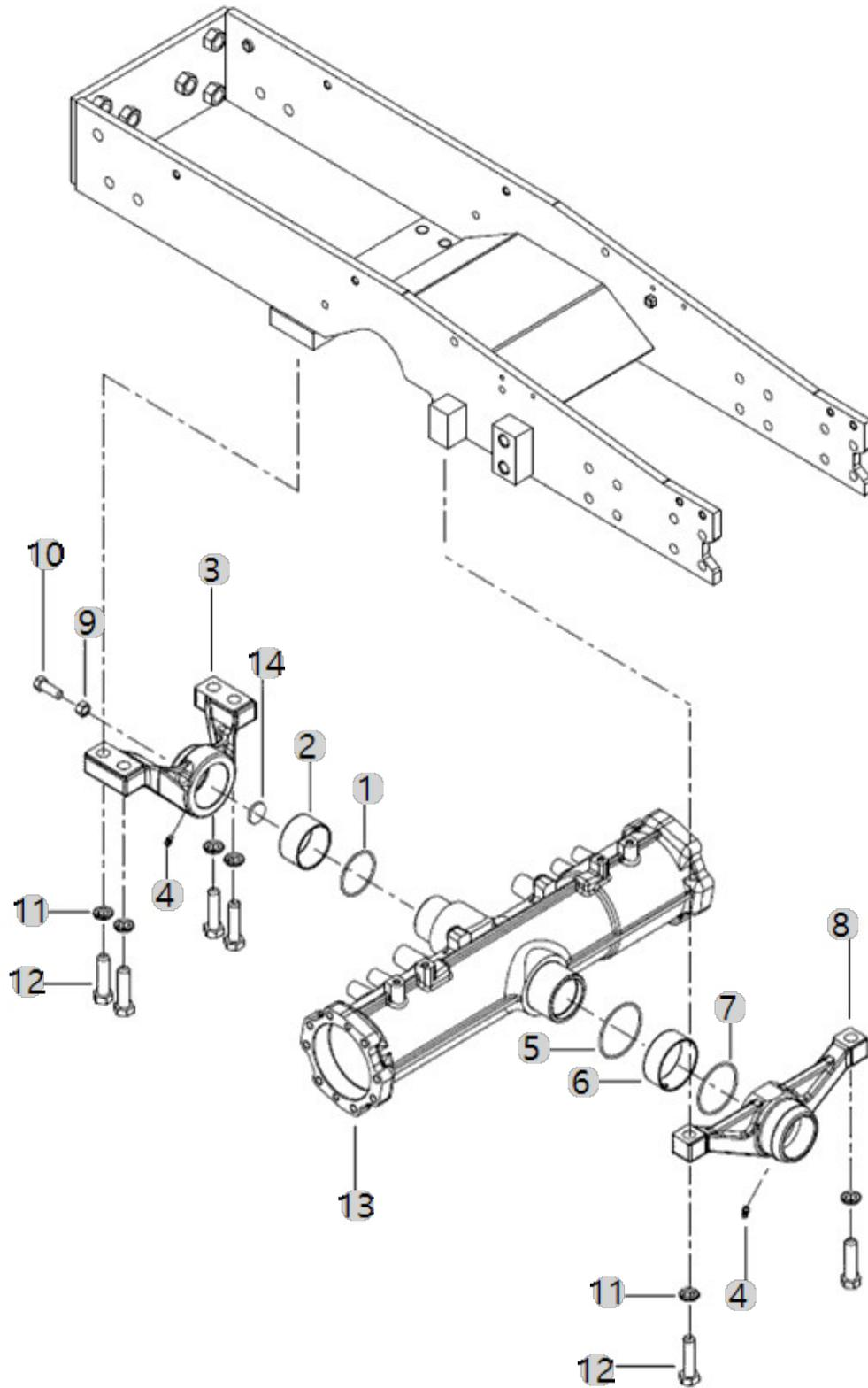



E01013

3015R\_US\_FL  
(AC02154)

(SPACER)

Year/Month

2022-12-14

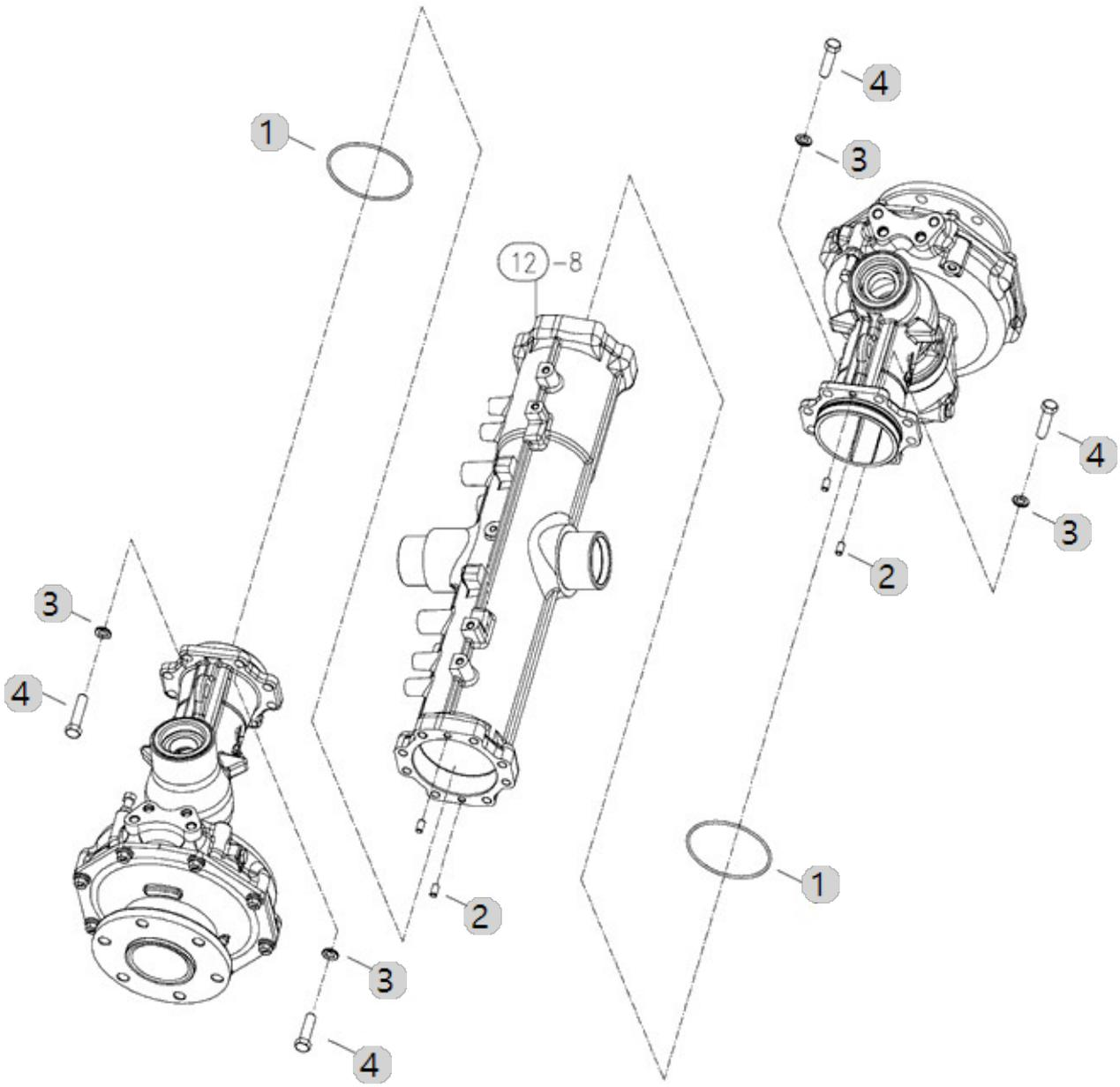





E01030

3015R\_US\_FL  
(AC02154)

(GEAR CASE, FRONT AXLE)

Year/Month

2022-12-14

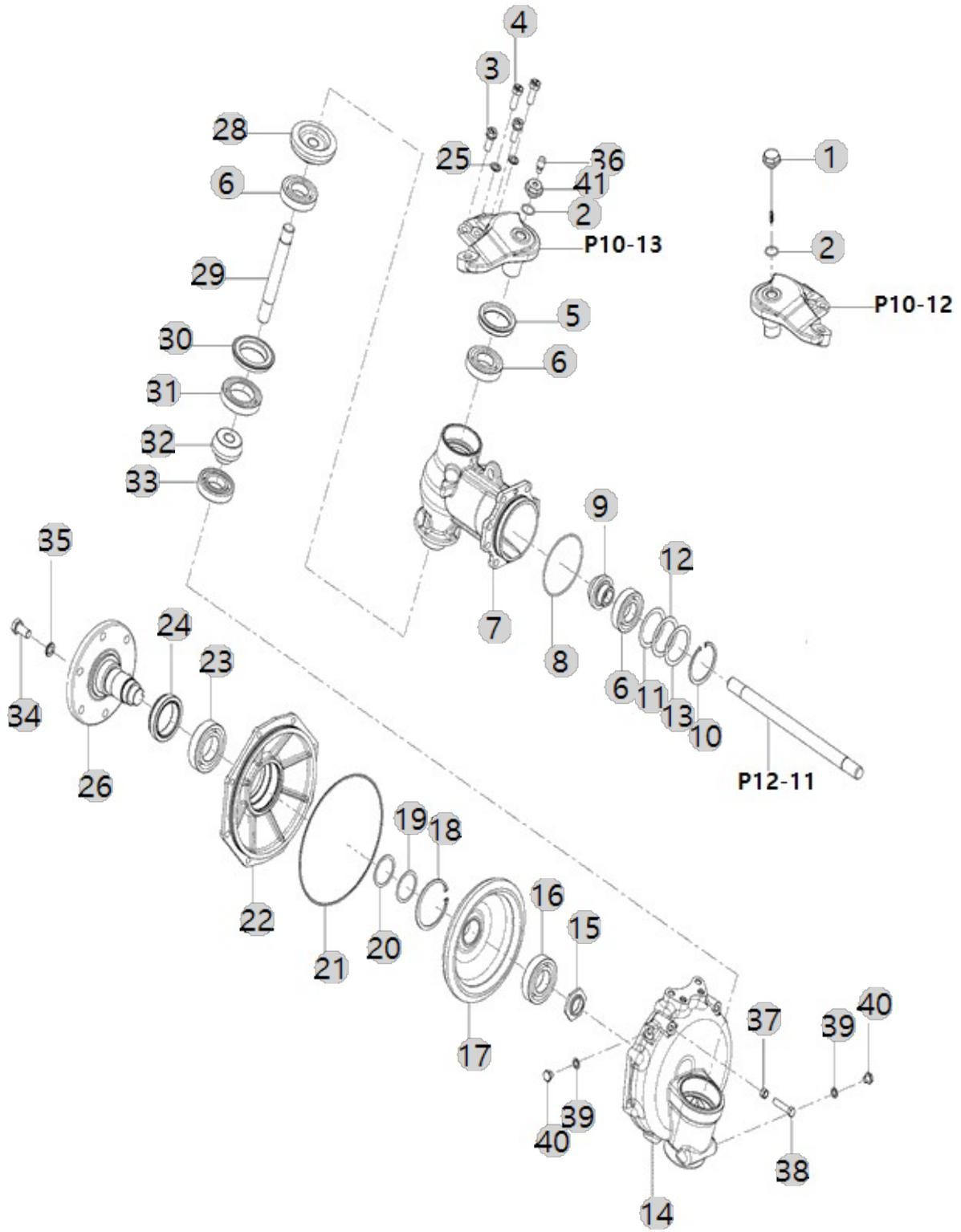

E01030 3015R_US_FL (AC02154)		(GEAR CASE, FRONT AXLE)				Year/Month 2022-12-14
순번 (NO)	부품번호 (PART NO)	품명 (PART NAME)	품명 (PART NAME)	수량 (QTY)	규격 (SPEC)	비고 (REMARK)
36	TA00049842B	에어브리더(STEEL)	AIR BREATHER	1		
1	TA00033805A	검유봉	OIL GUAGE	1		
2	24311-000220	O-RING1AP-22.0	O-RING, DYNAMIC (Φ22)	2	1A P22.0	
3	TA00033468C	와셔조립육각볼트	BOLT W/ WASHER	4		
4	TA00033475B	리머볼트	SPACER	4		
5	FE78010000B	오일실 (특수) 55x72x13.5	OIL SEAL (55X72X13.5)	2	55X72X13.5	
6	24101-062074	볼베어링6207	BALL BEARING (#6207)	6	#6207	
7	TA00033457C	프런트기어케이스	CASE, FRONT GEAR	2		
8	24321-001050	O-링	O-RING	2		
9	TA00033461B	전1축피니언9T	PINION, FRONT 1ST SHAFT	2		
10	22252-000720	구멍용스냅링72	RING, CIRCLIP (Φ 72)	2	D72	
11	TA00033489A	심 0.2T	SHIM 0.2T	2		
12	TA00033488A	심 0.3T	SHIM 0.3T	2		
13	TA00033487A	심 0.5T	SHIM 0.5T	2		
14	TA00033458C	프런트기어박스	GEAR BOX, FRONT	2		
15	TA00033481A	로크너트	LOCK NUT	2		
16	24101-062084	볼베어링6208	Bearing, Ball (#6208)	2	#6208	
17	TA00033474A	베벨기어 49T	GEAR, BEVEL 49T	2		
18	22252-000850	써클립85H	RING, CIRCLIP (Φ 85)	2		
19	TA00033486A	심 0.2T	SHIM 0.2T	1		
20	TA00033485A	심 0.5T	SHIM 0.5T	1		
21	TA00033939A	O링	O RING	2		
22	TA00033459C	프런트베어링케이스	BEARING CASE, FRONT	1		
23	24101-062094	볼베어링6209	BALL BEARING (#6209)	2	#6209	
24	TA00041359A	오일씰	OILSEAL	2		
25	22217-120000	스프링와셔	WASHER, SPRING (Φ 12)	2	M12	
26	TA00033460D	프런트스핀들	SPINDLE, FRONT	2		
26	TA00033460C	프런트스핀들	SPINDLE, FRONT	2		
26	TA00033460E	프런트스핀들	SPINDLE, FRONT	2		
27	TA00033469B	와셔조립육각볼트	BOLT W/ WASHER	16		
28	TA00033463A	전2축기어	FRONT 2ND AXLE LH	2		
29	TA00033464A	전2축	FRONT 2ND SHAFT	2		
30	TC60110000A3	오일실(AJ)	SEAL, OIL	2		
31	24101-060104	볼베어링6010	Bearing, Ball (#6010)	2	#6010	
32	TA00033473A	베벨기어 11T	GEAR, BEVEL 11T	2		
33	TC60340000A4	베어링TM207C3	BEARING(TM207C3)	2	TM207C3	
34	TD23120000B4	프런트 허브 볼트(M14X28)	BOLT	12	M14XP1.5	
35	22217-140000	스프링와셔14	WASHER, SPRING (Φ 14)	12	M14	
36	TA00049842A	에어브리더(STEEL)	AIR BREATHER	1		
37	26716-100001	육각너트	NUT	2		
38	26112-100452	육각볼트	BOLT	2		
39	22190-100000	실와셔	WASHER	4	M10	
40	23887-100002	플러그(미터)	SCREW,HEXAGONHEADCAP	4	M10	
41	TA00049843B	에어브리더 플러그	ADAPThER	1		

E01070

3015R\_US\_FL  
(AC02154)

(FRONT DRIVE SHAFT)

Year/Month

2022-12-14

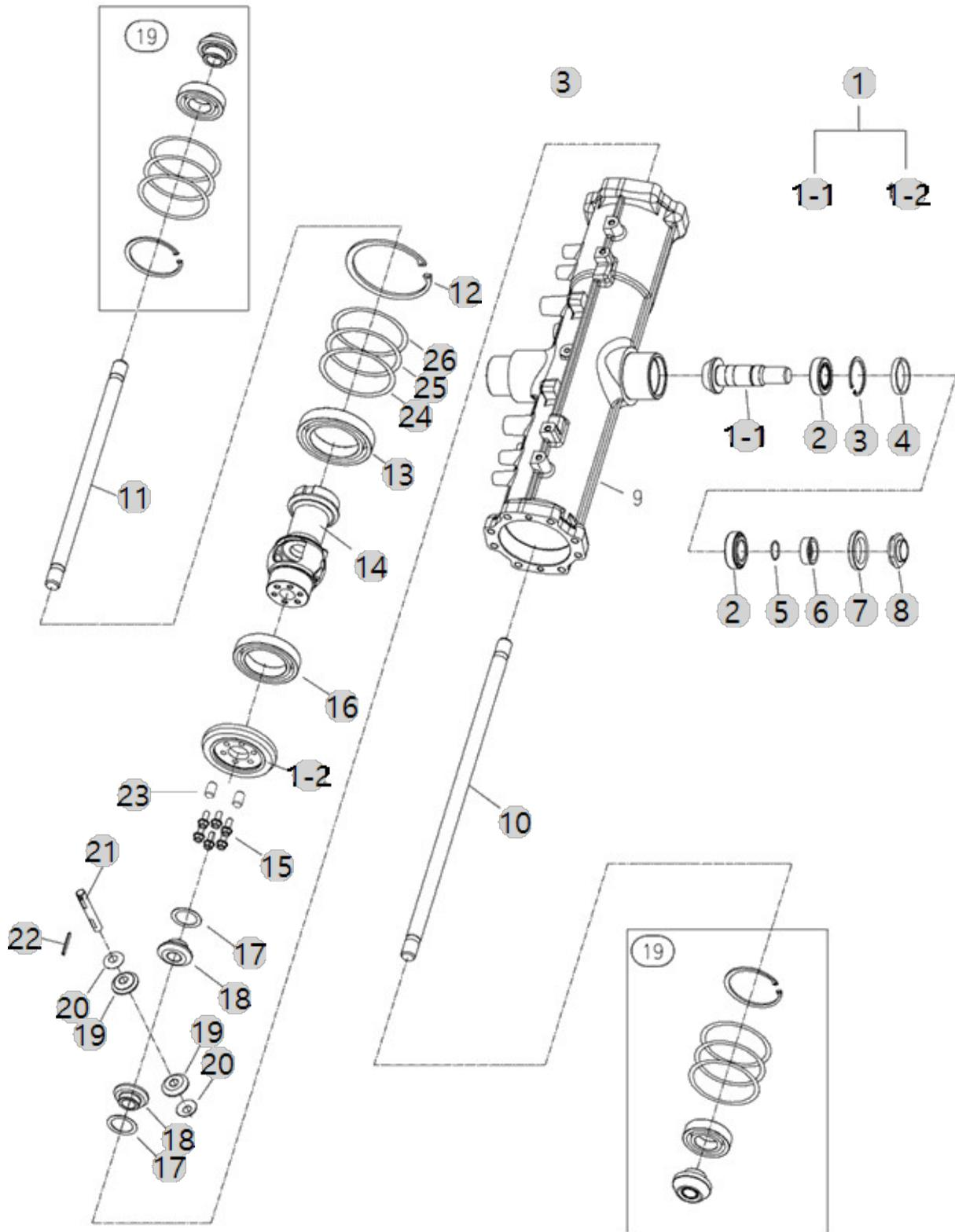



E01080

3015R\_US\_FL  
(AC02154)

(TIE ROD)

Year/Month

2022-12-14

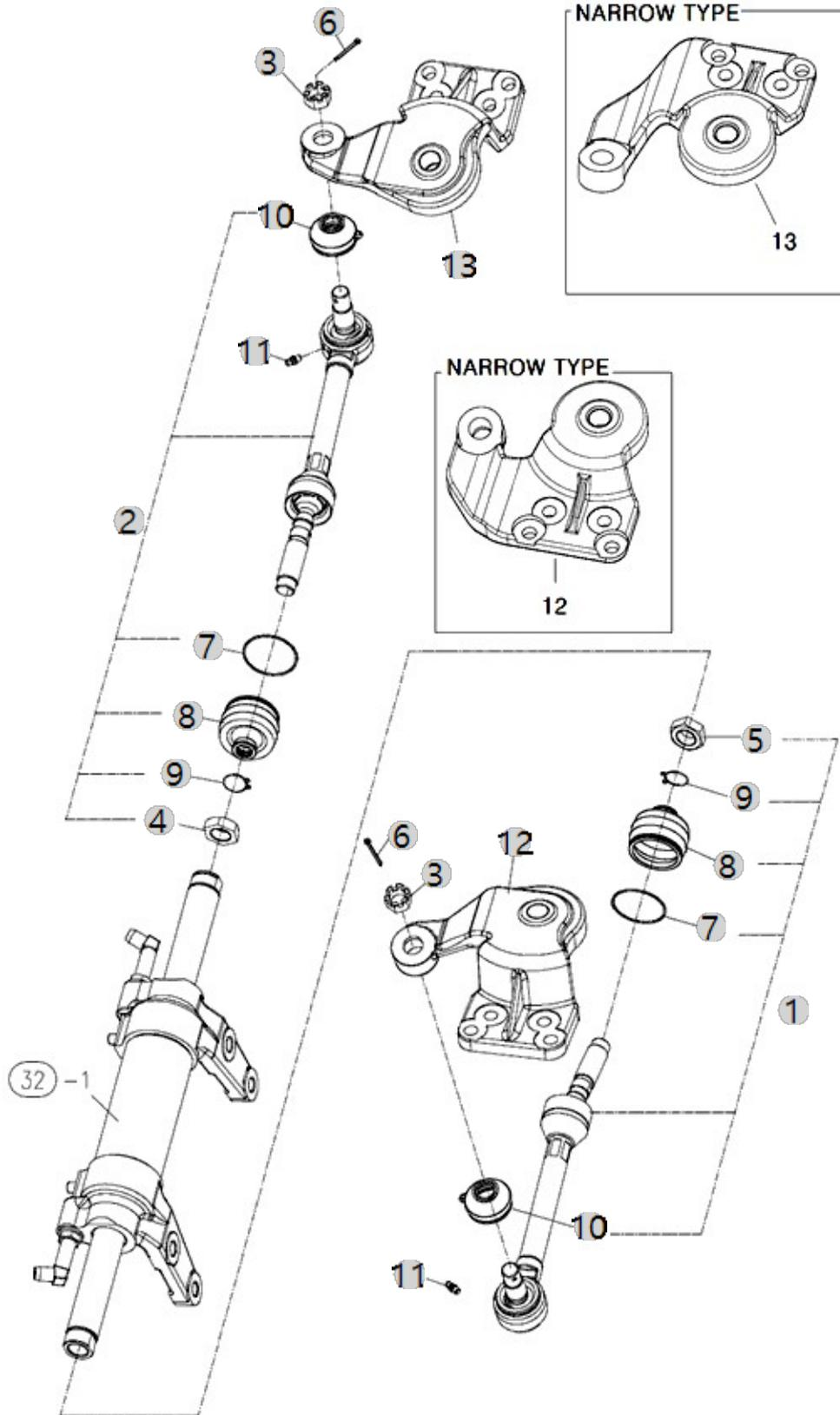



F01010-B

BRANSON 15R  
TM\_US\_FL(AC01899)

(CLUTCH HOUSING)

Year/Month

2022-12-14

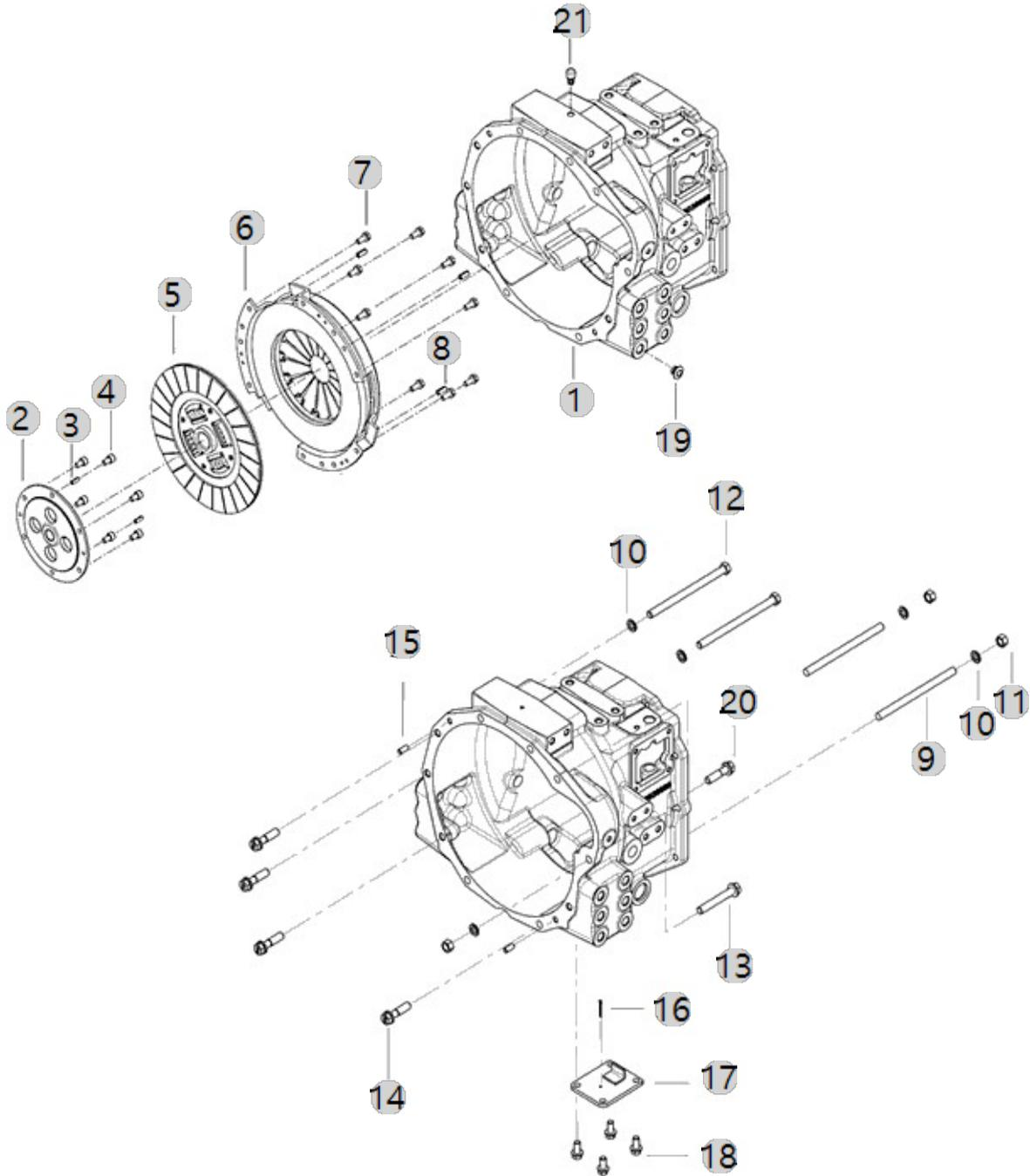





F01020

BRANSON 15R  
TM\_US\_FL(AC01899)

(TRANSMISSION CASE)

Year/Month

2022-12-14

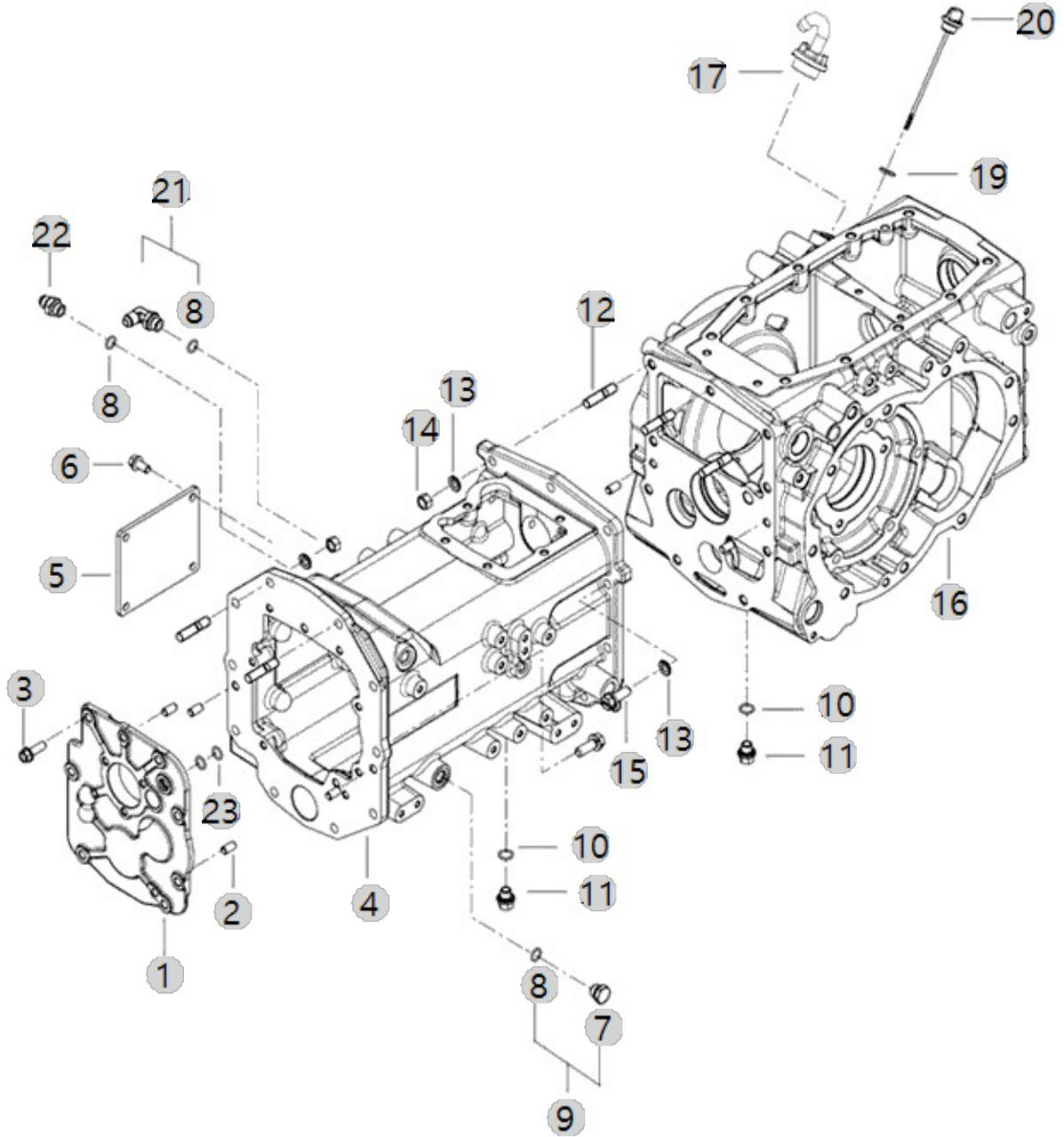



F01030

BRANSON 15R  
TM\_US\_FL(AC01899)

(REAR AXLE HOUSING)

Year/Month

2022-12-14

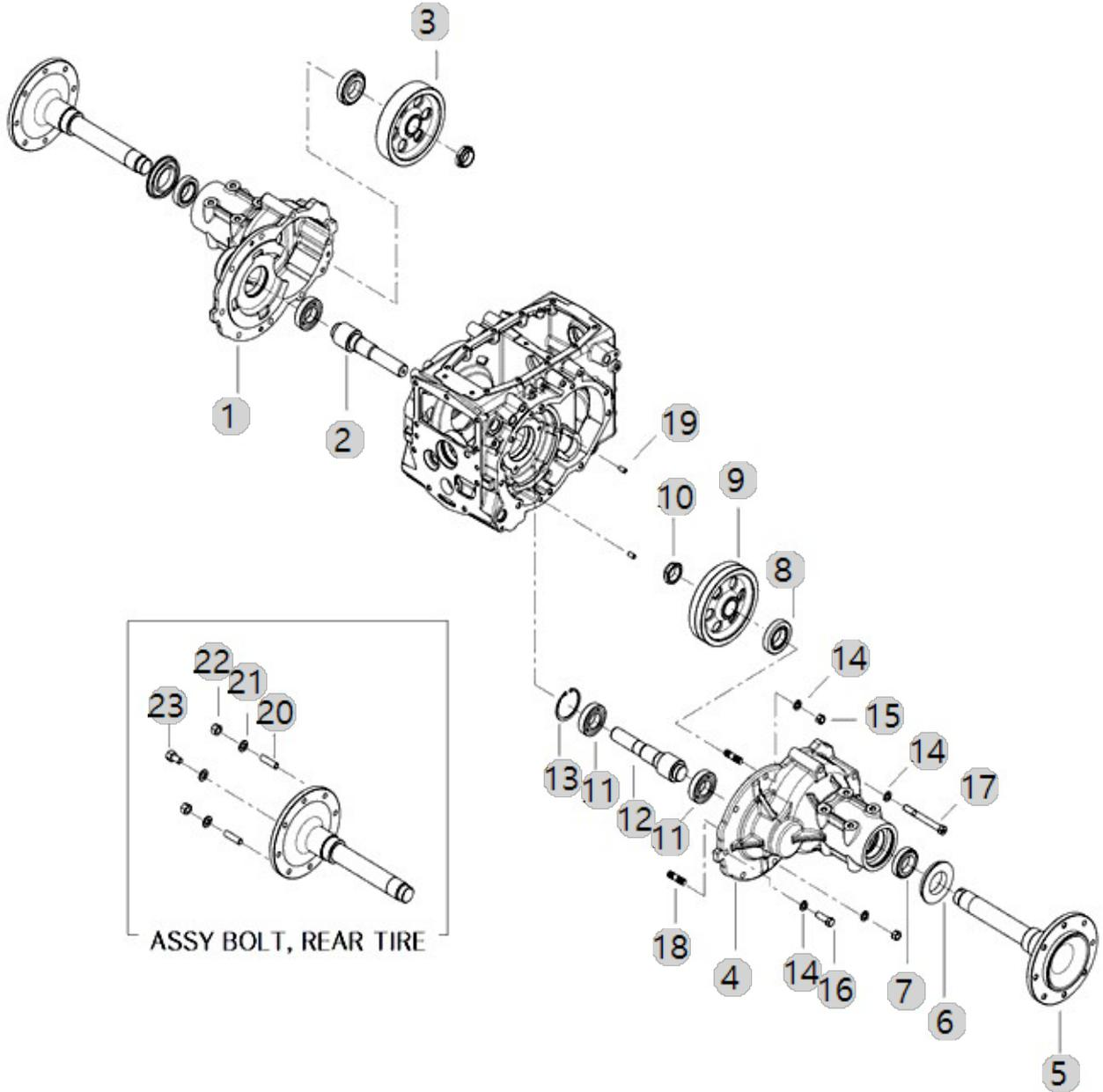



F02010

BRANSON 15R  
TM\_US\_FL(AC01899)

(CLUTCH RELEASE)

Year/Month

2022-12-14

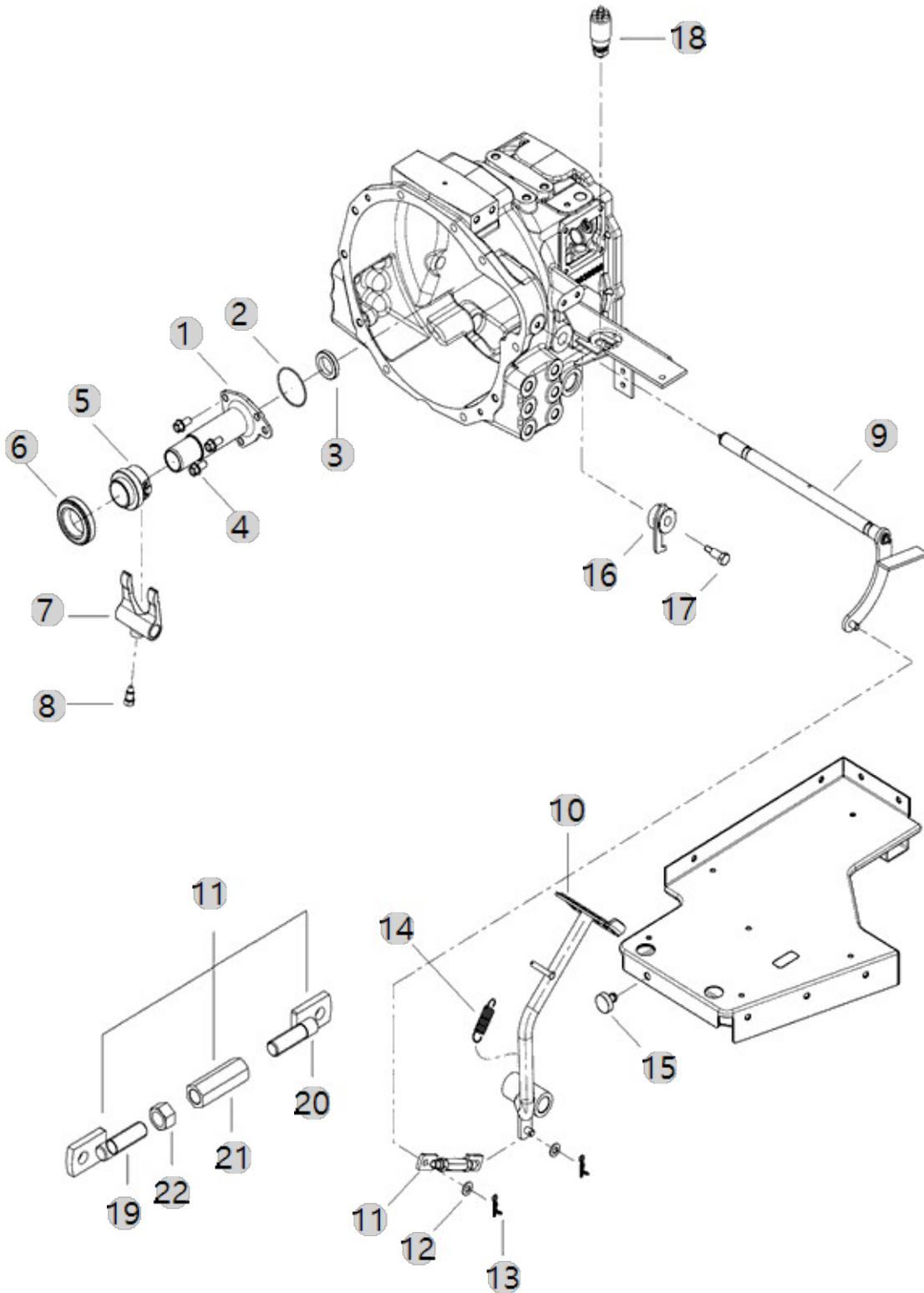



F02020

BRANSON 15R  
TM\_US\_FL(AC01899)

(CLUTCH SHAFT)

Year/Month

2022-12-14

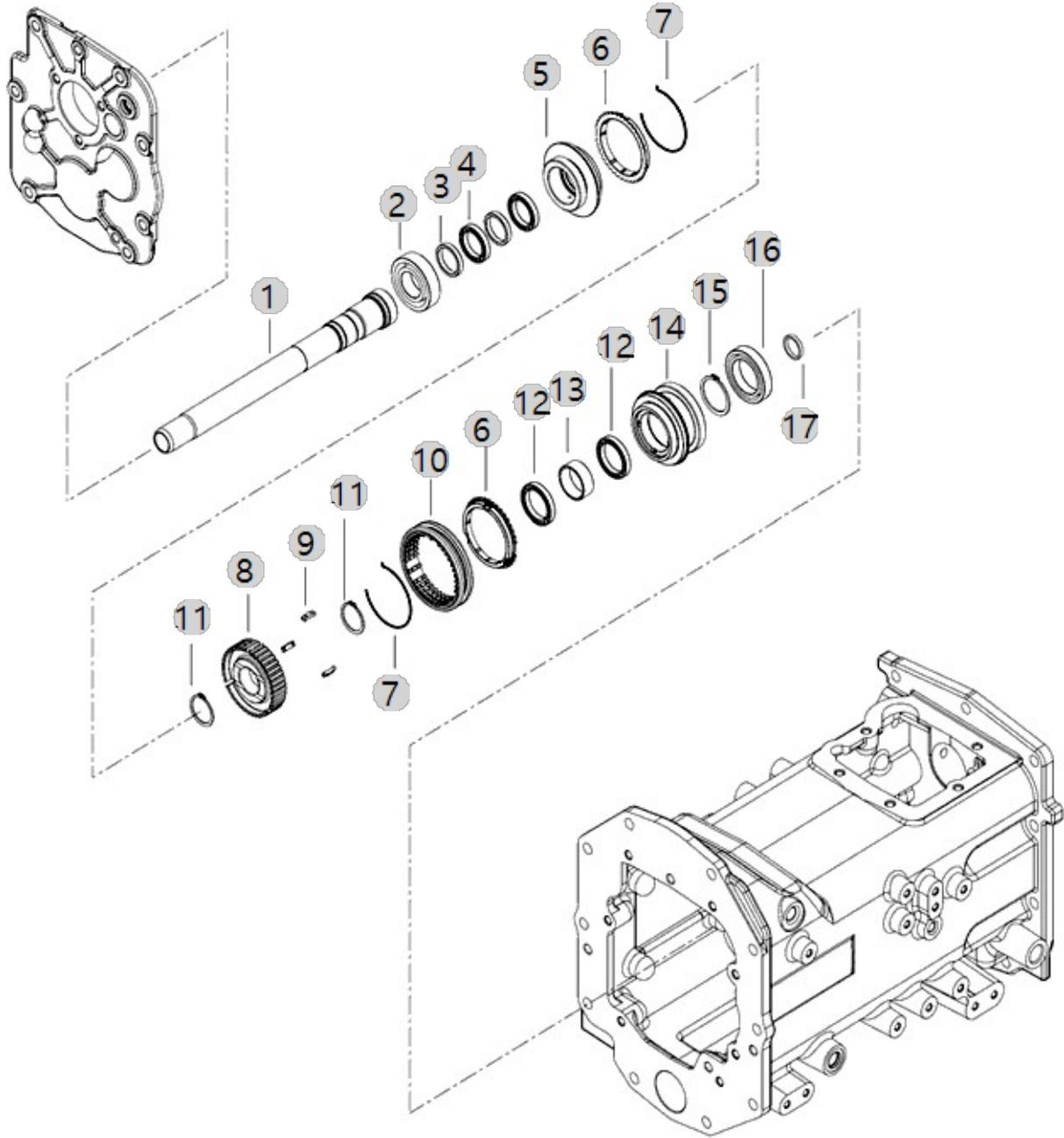





F03010

BRANSON 15R  
TM\_US\_FL(AC01899)

(MAIN SHIFT DRIVE SHAFT)

Year/Month

2022-12-14

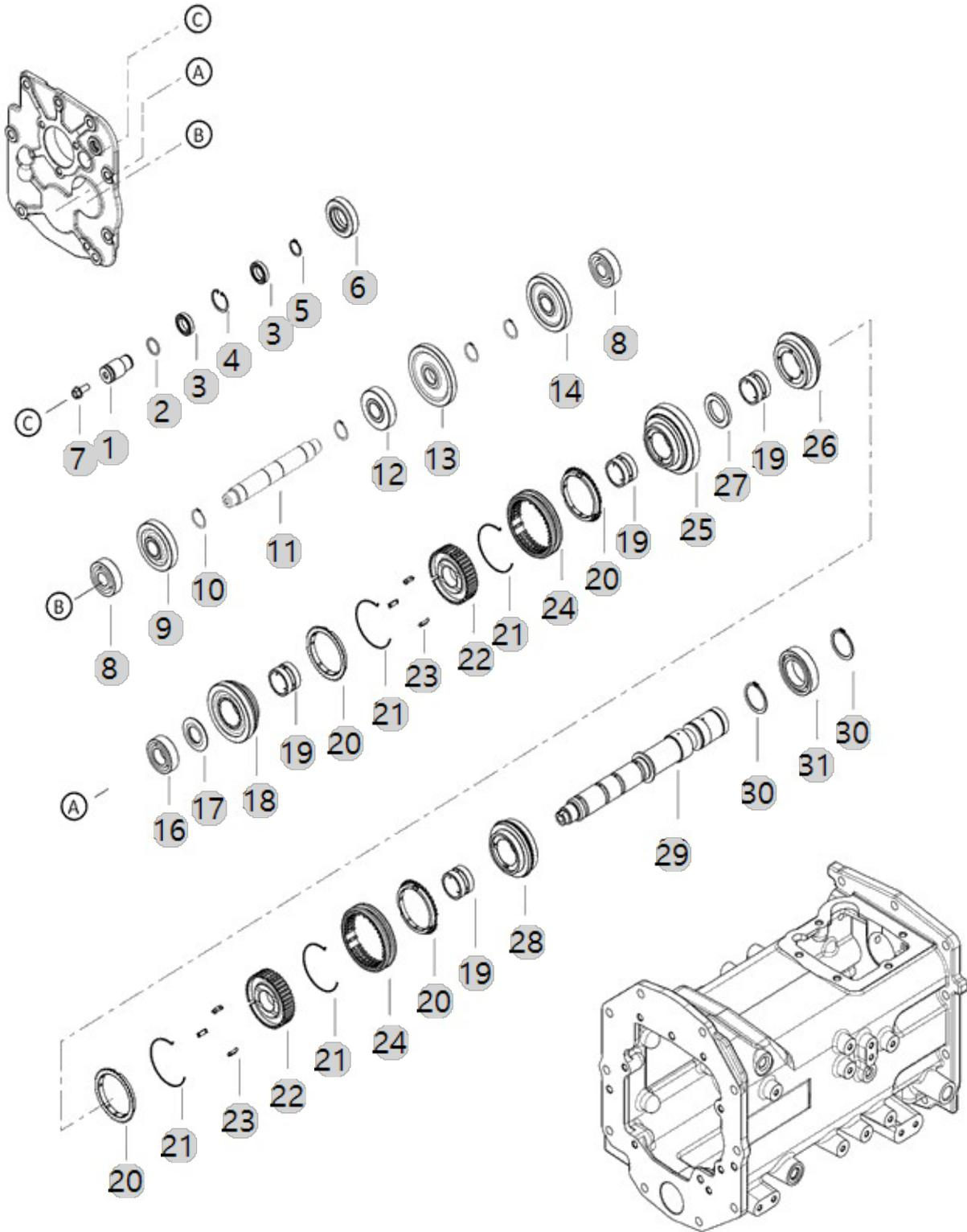



F03040

BRANSON 15R  
TM\_US\_FL(AC01899)

(RANGE SHIFT DRIVE SHAFT)

Year/Month

2022-12-14

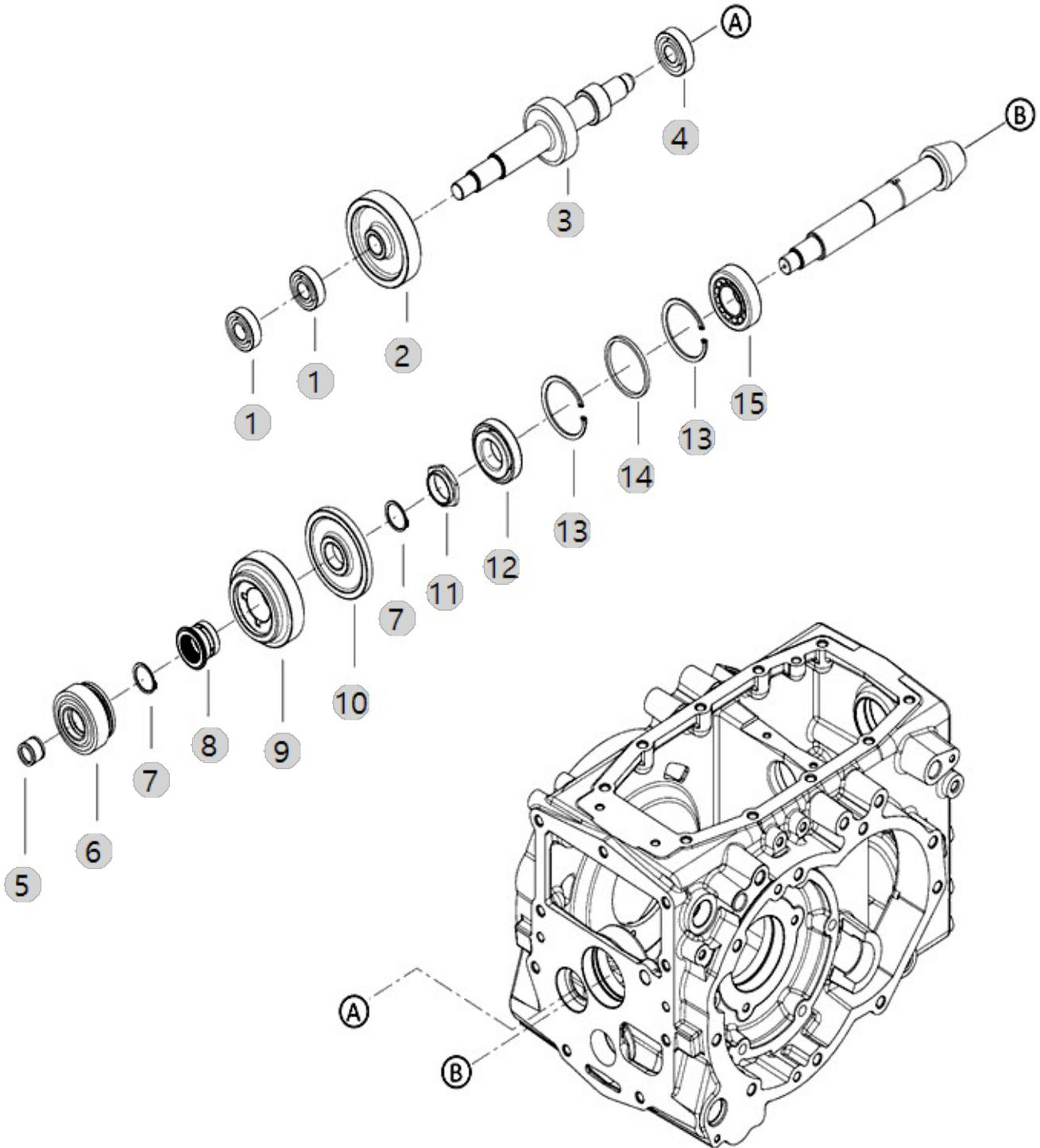



F04010

BRANSON 15R  
TM\_US\_FL(AC01899)

(FRONT DRIVE SHAFT)

Year/Month

2022-12-14

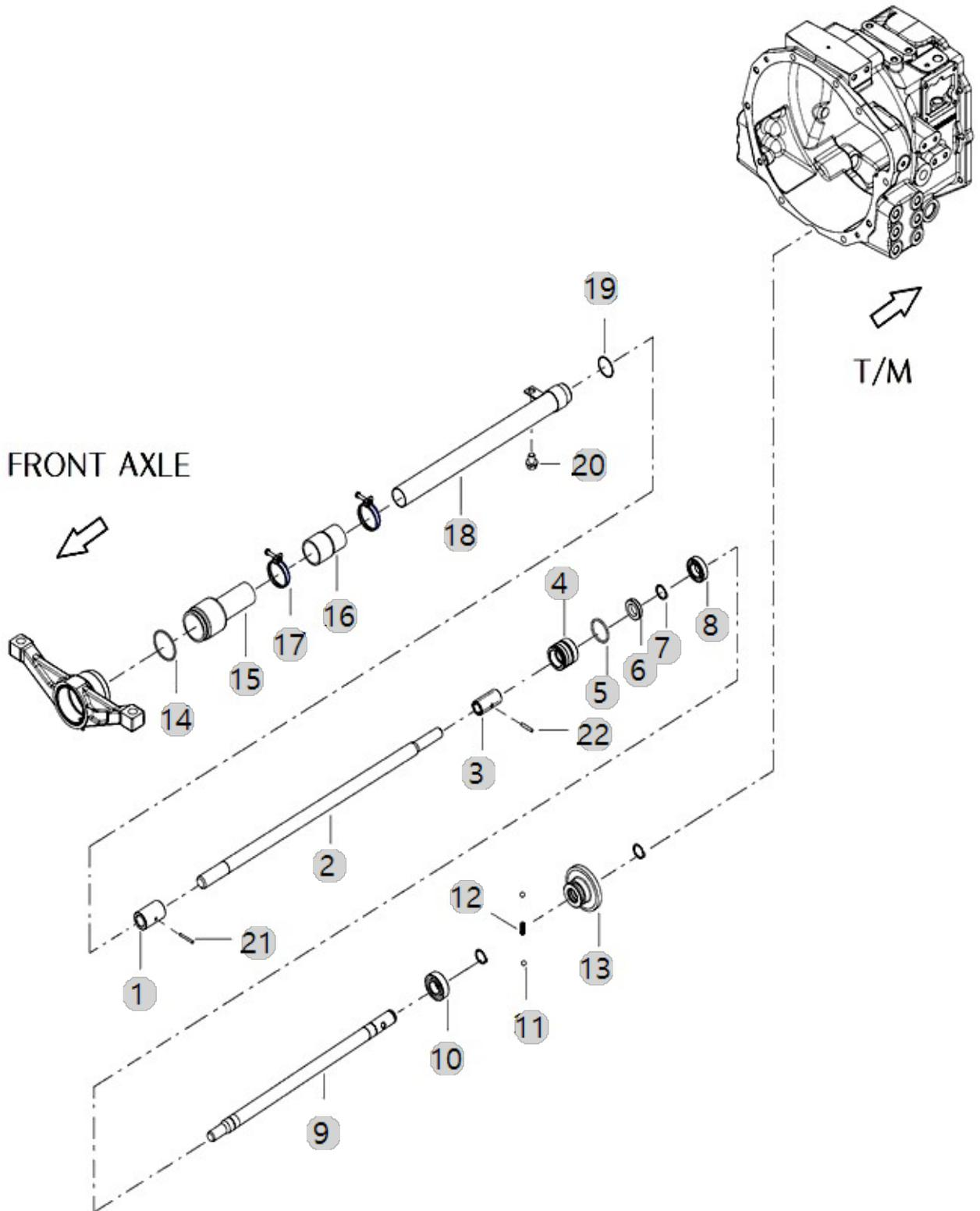



F05020

BRANSON 15R  
TM\_US\_FL(AC01899)

### RING GEAR&DIFF.GEAR ASS'Y

Year/Month

2022-12-14

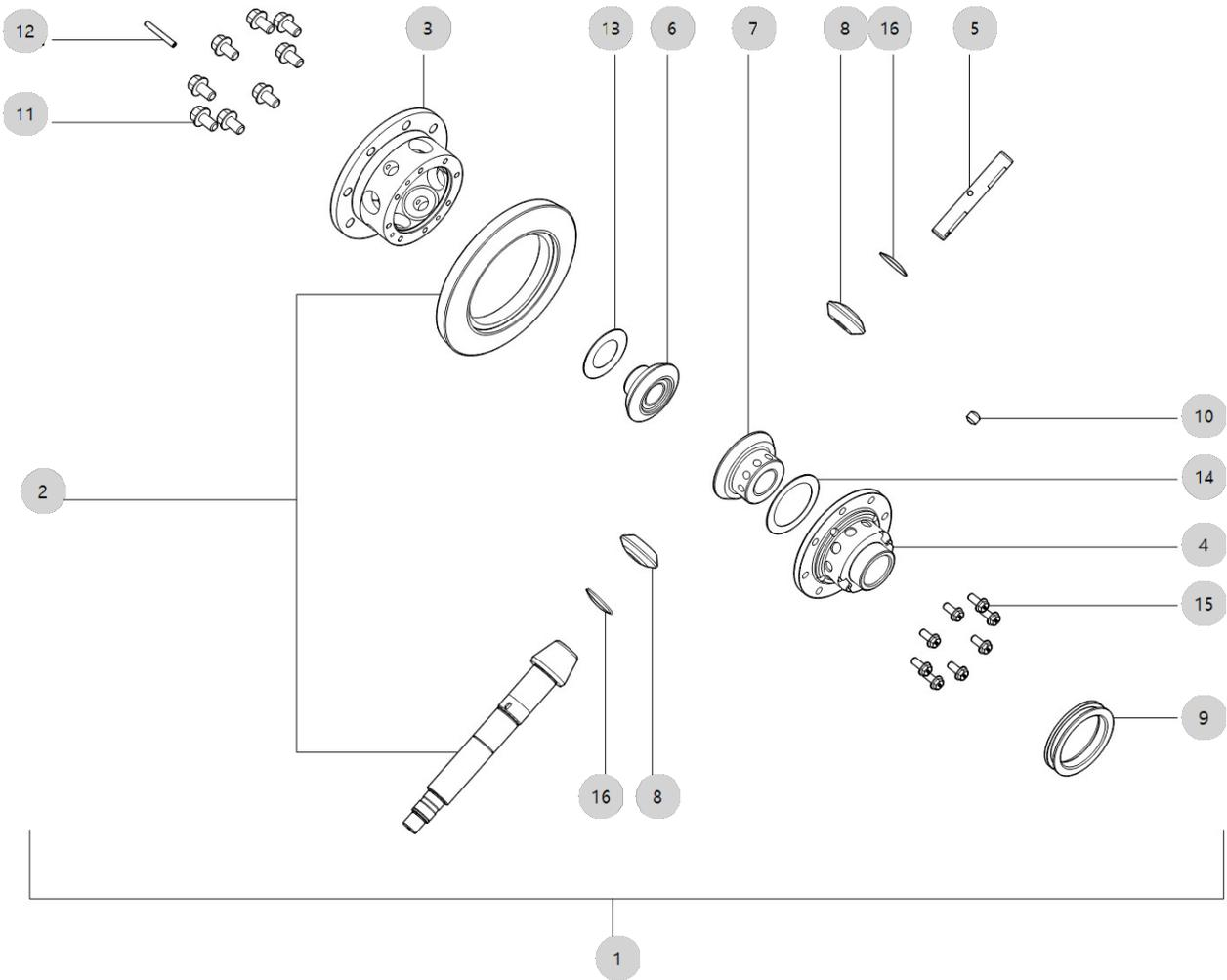





F05020

BRANSON 15R  
TM\_US\_FL(AC01899)

(REAR DIFFERENTIAL ASS'Y)

Year/Month

2022-12-14

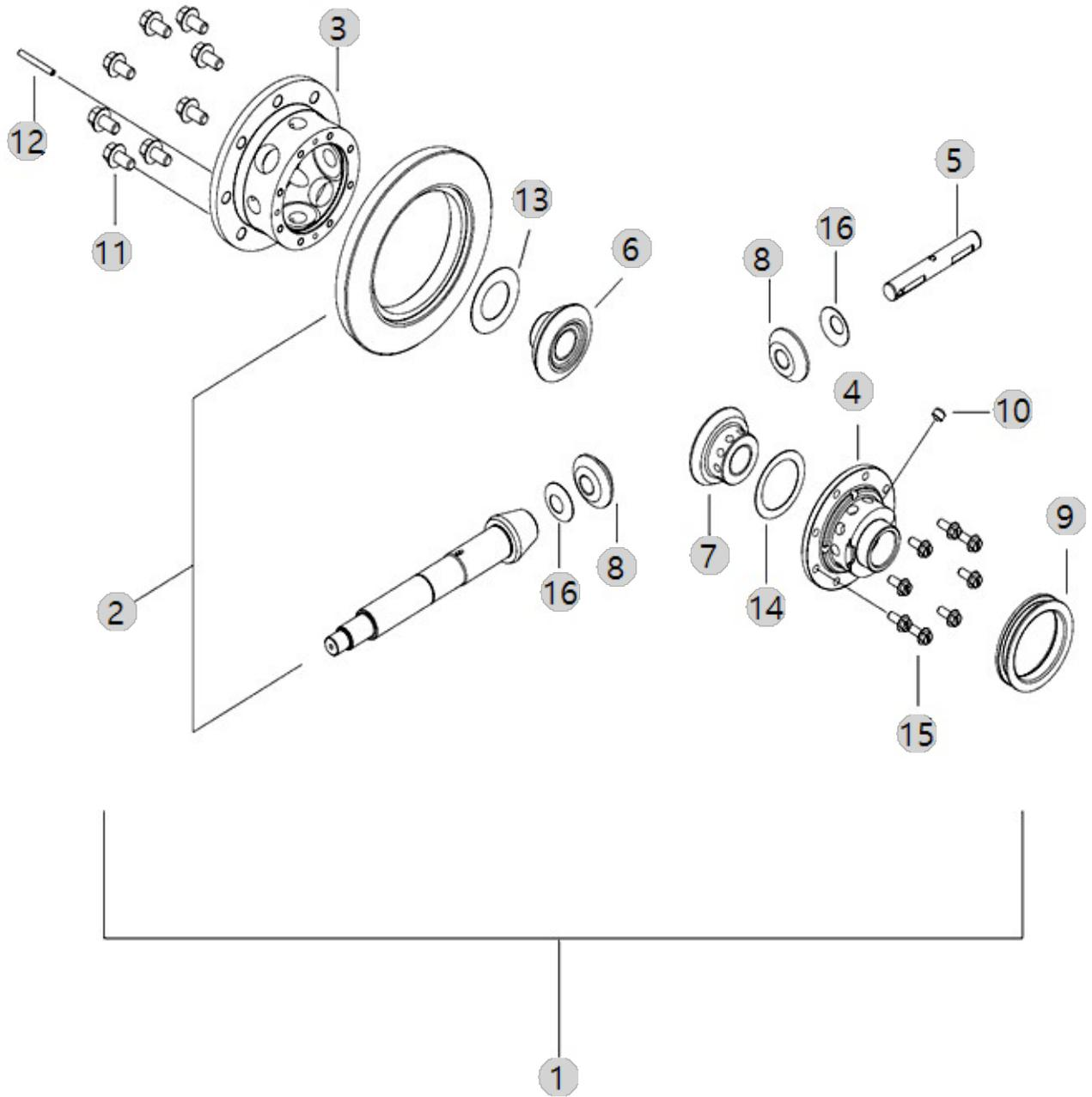



F06030

BRANSON 15R  
TM\_US\_FL(AC01899)

(BRAKE)

Year/Month

2022-12-14

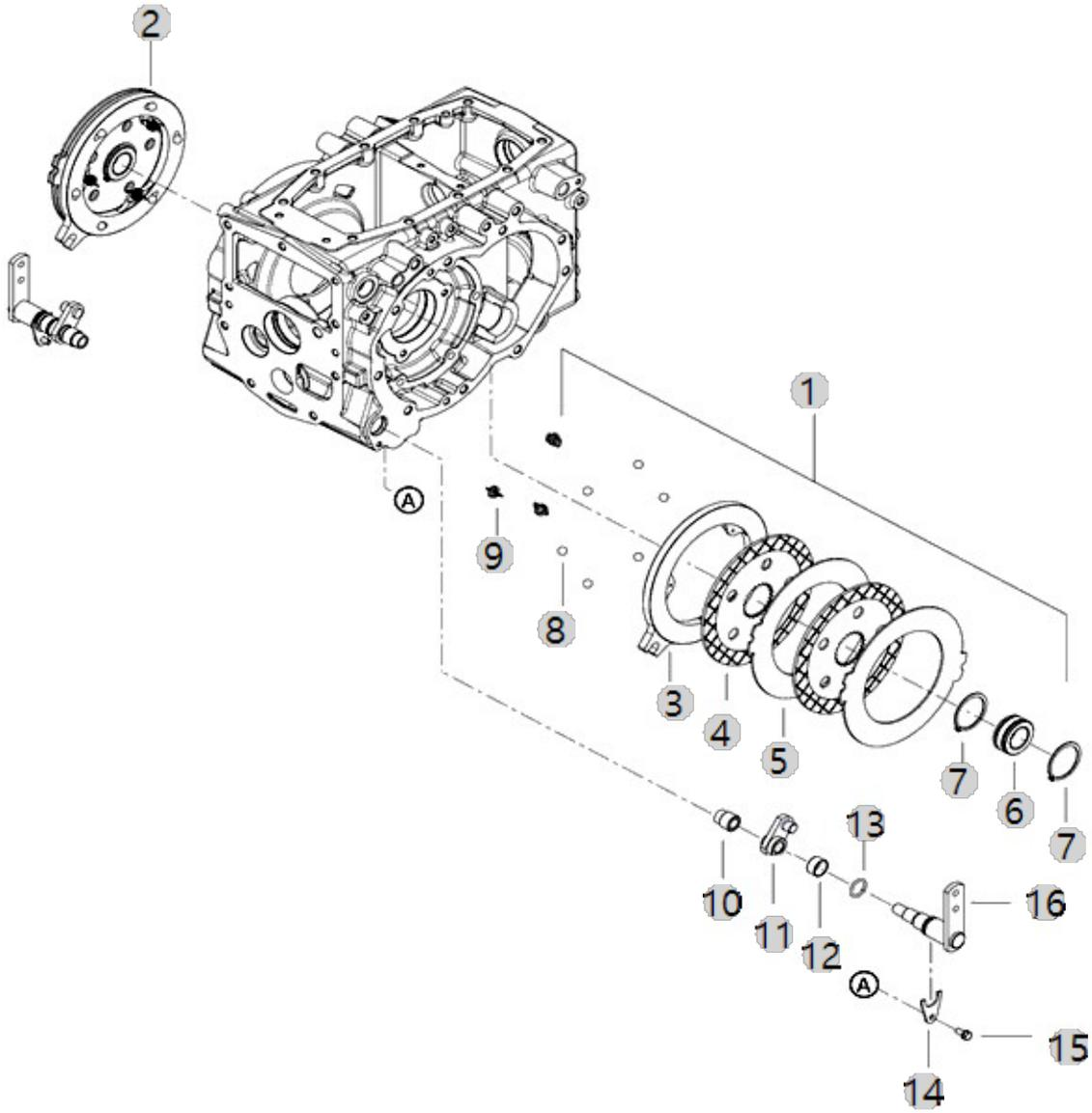



F07030

BRANSON 15R  
TM\_US\_FL(AC01899)

(PTO DRIVE SHAFT)

Year/Month

2022-12-14

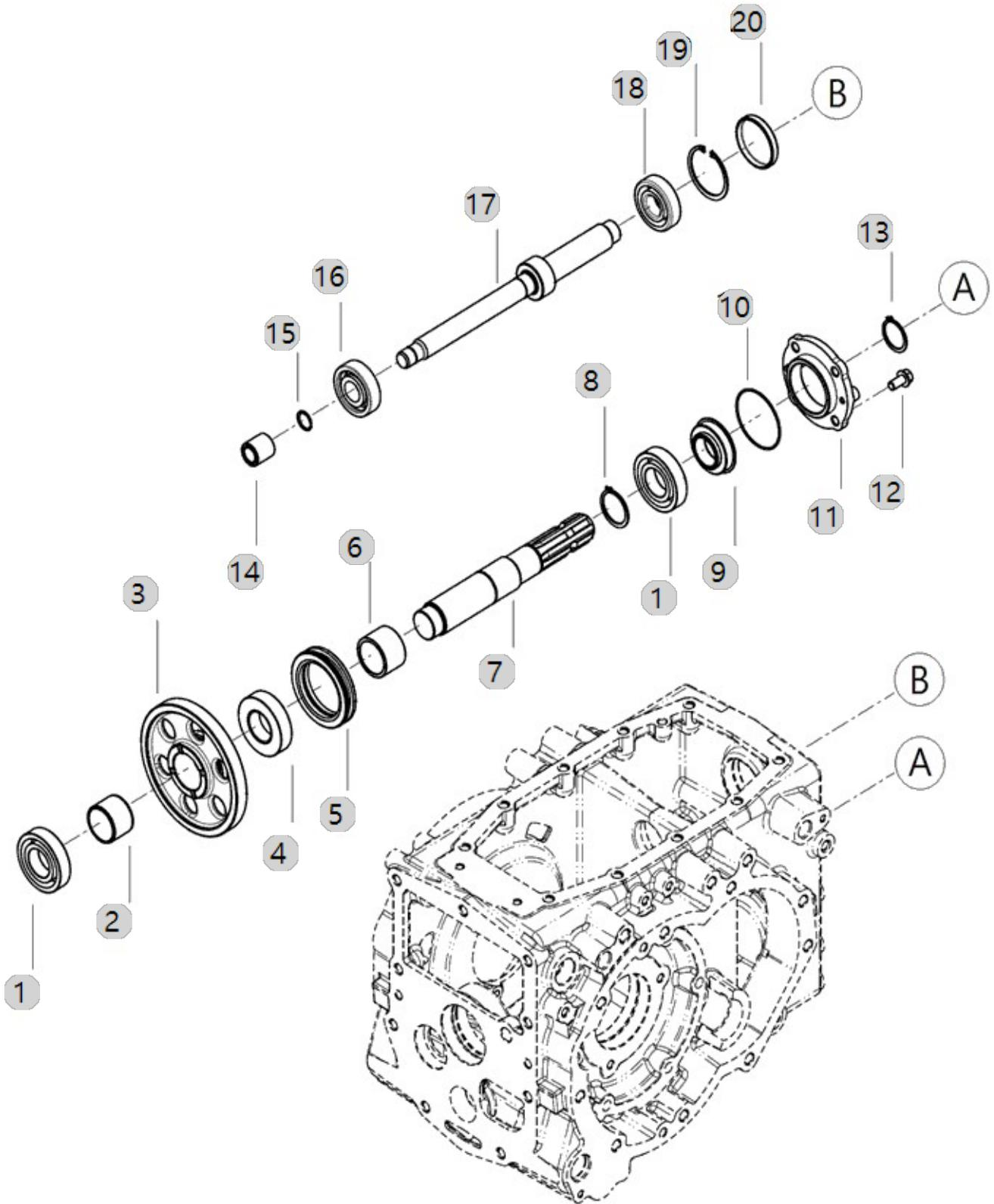









F08021

BRANSON 15R  
TM\_US\_FL(AC01899)

(FORK, PTO SHIFT)

Year/Month

2022-12-14

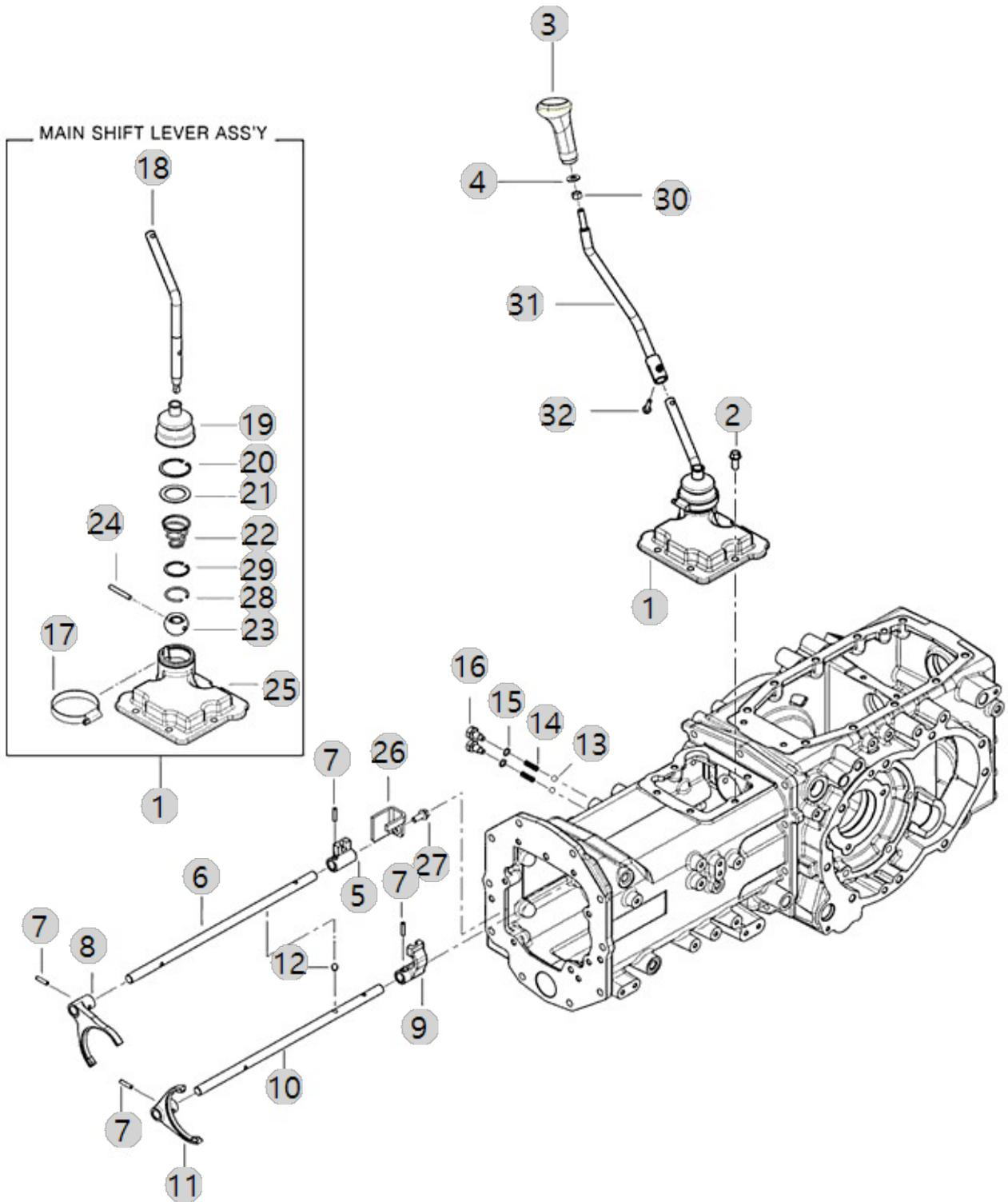



F08060

BRANSON 15R  
TM\_US\_FL(AC01899)

(FORK, MAIN SHIFT)

Year/Month

2022-12-14

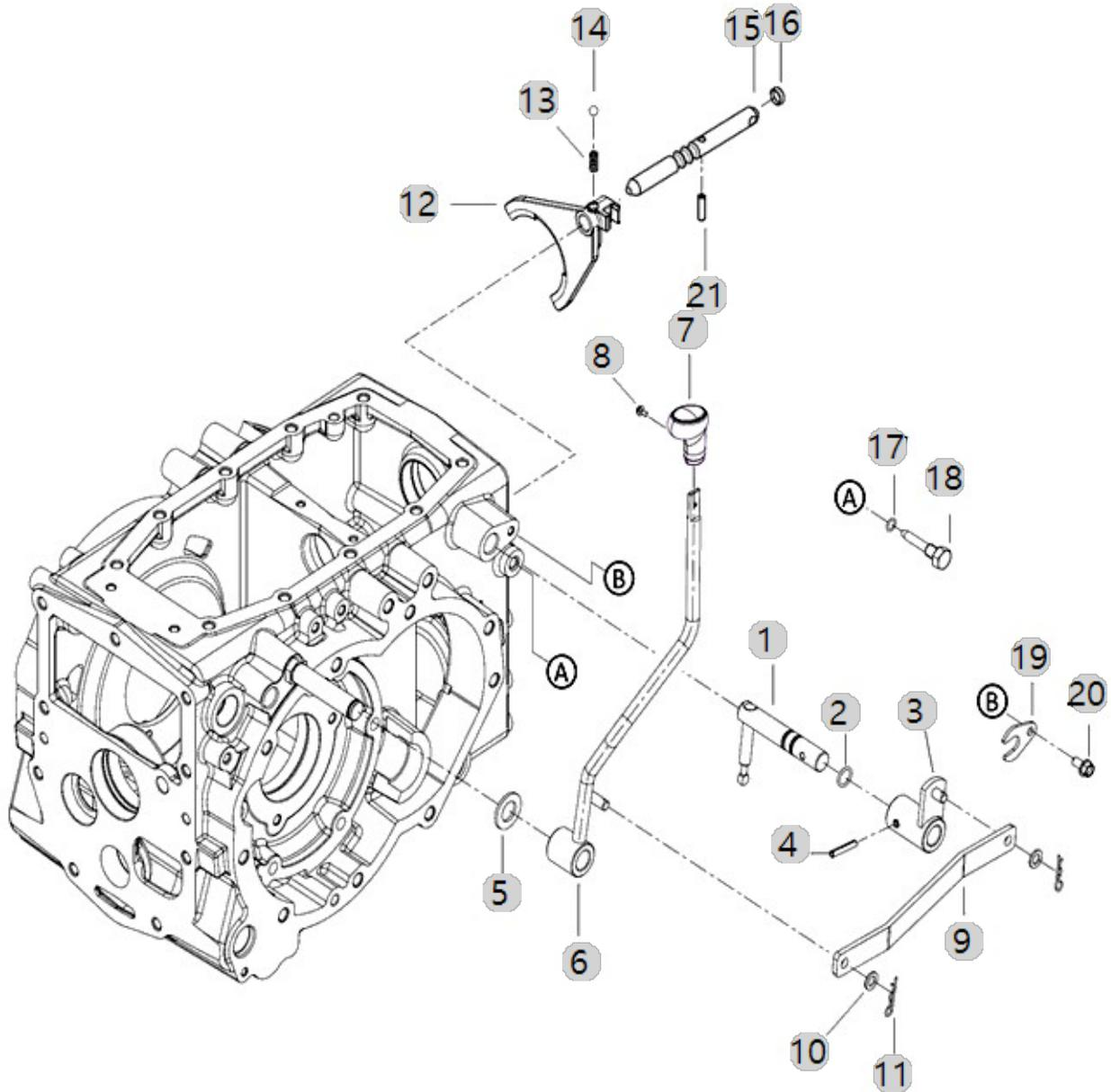



F10010

BRANSON 15R  
TM\_US\_FL(AC01899)

(CASE, HYD CYLINDER)

Year/Month

2022-12-14

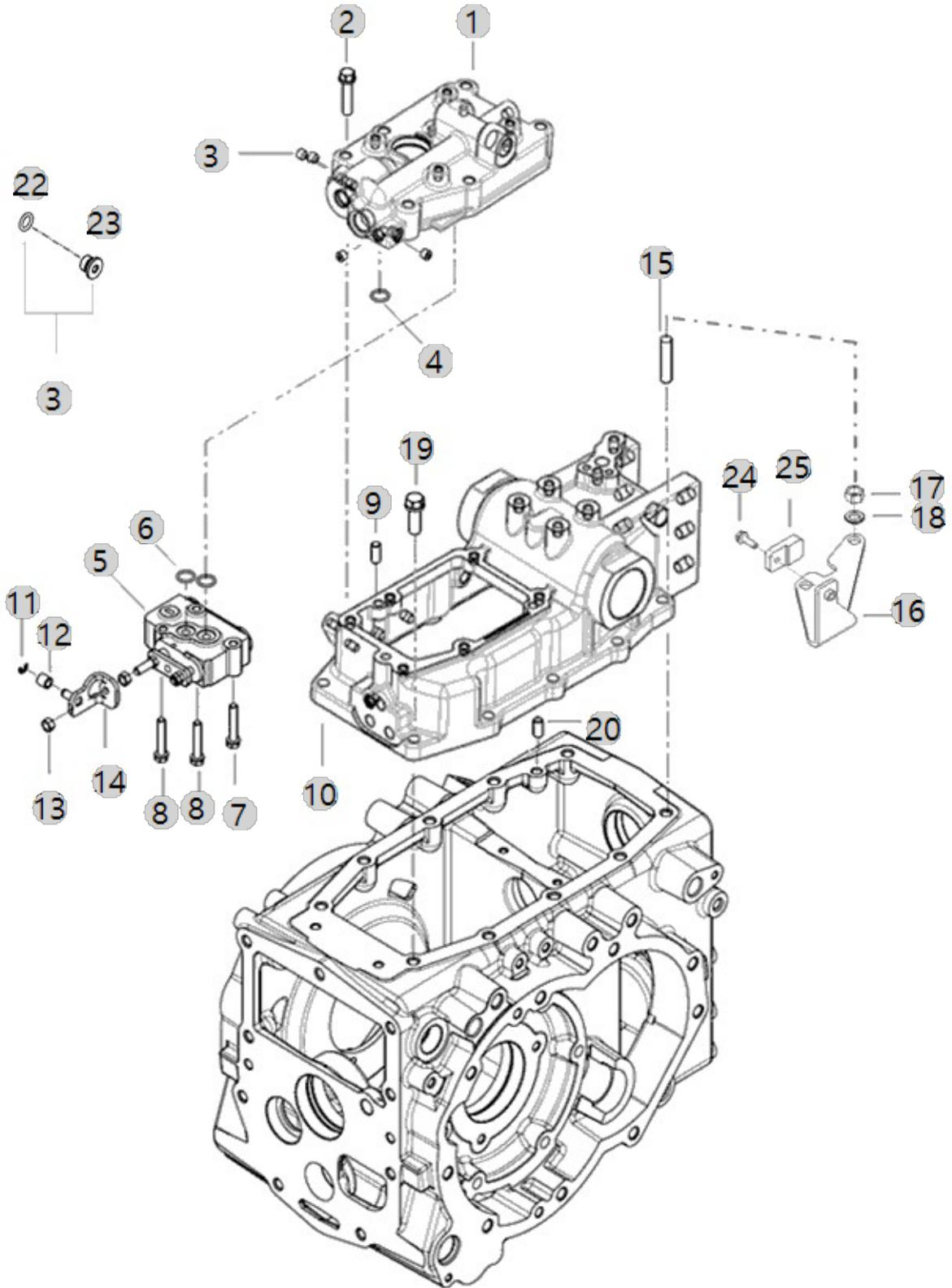



F10020

BRANSON 15R  
TM\_US\_FL(AC01899)

(LIFT ARM)

Year/Month

2022-12-14

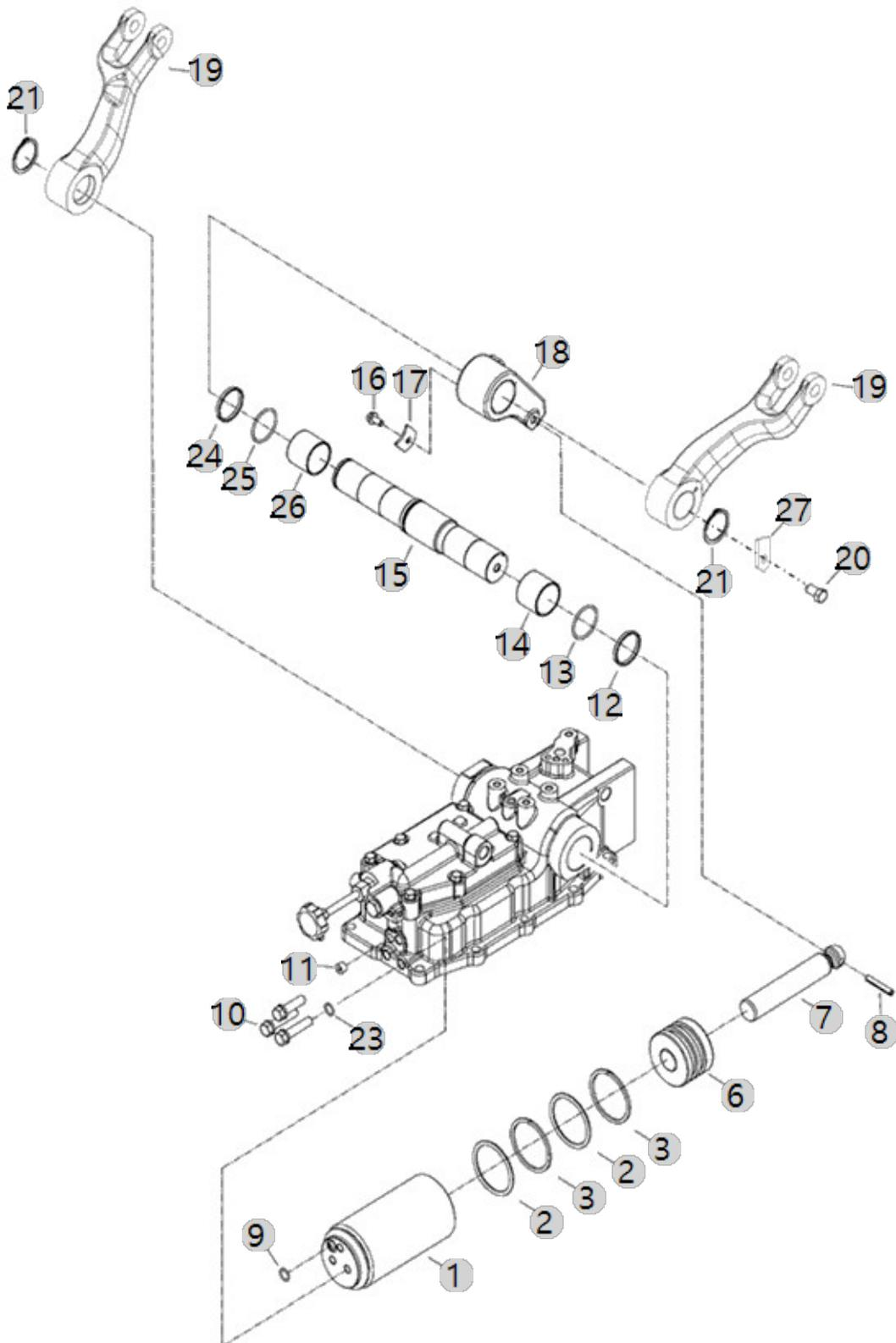





F10030

BRANSON 15R  
TM\_US\_FL(AC01899)

(SAFETY VALVE)

Year/Month

2022-12-14

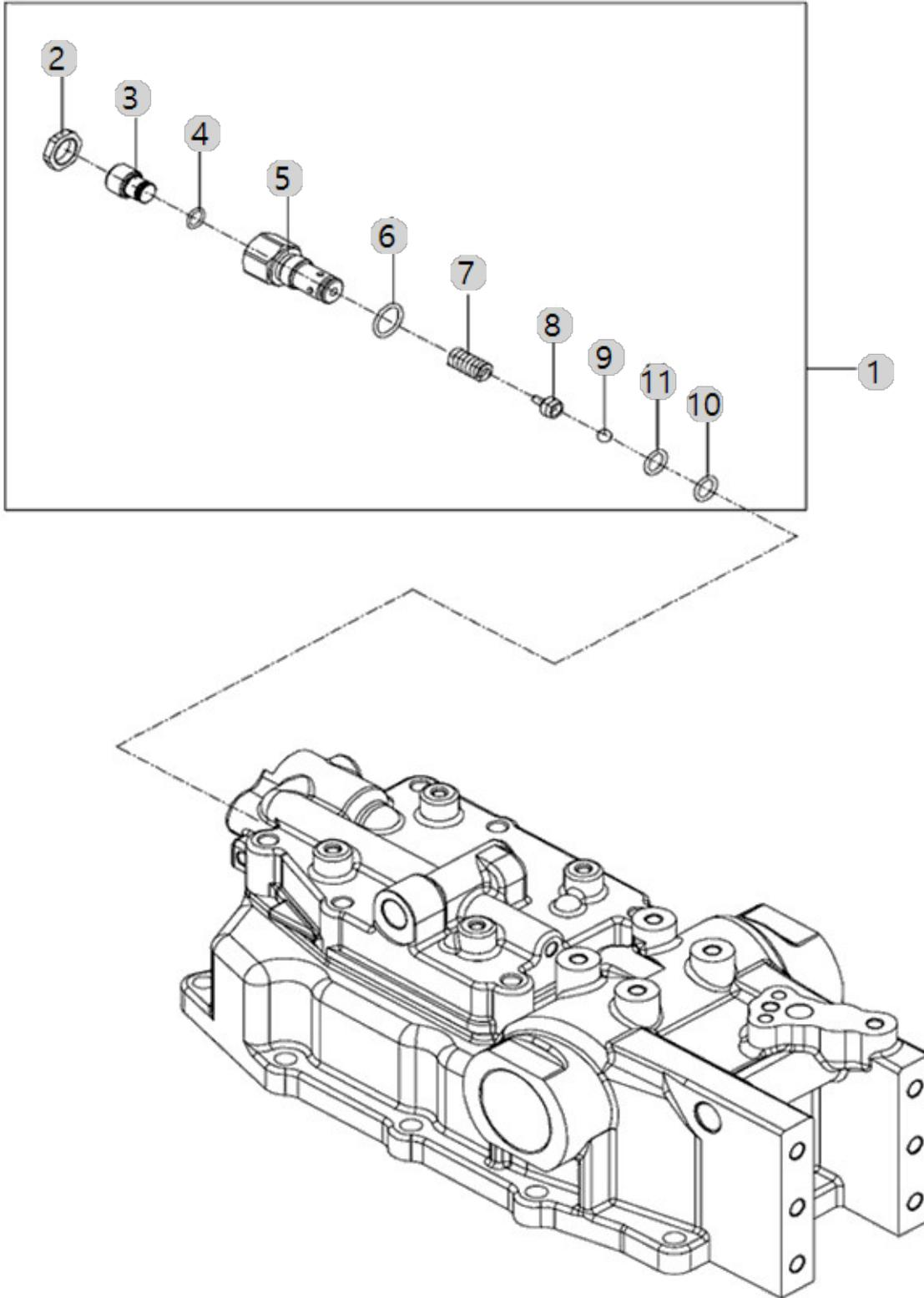



F10031

BRANSON 15R  
TM\_US\_FL(AC01899)

(RELIEF)

Year/Month

2022-12-14

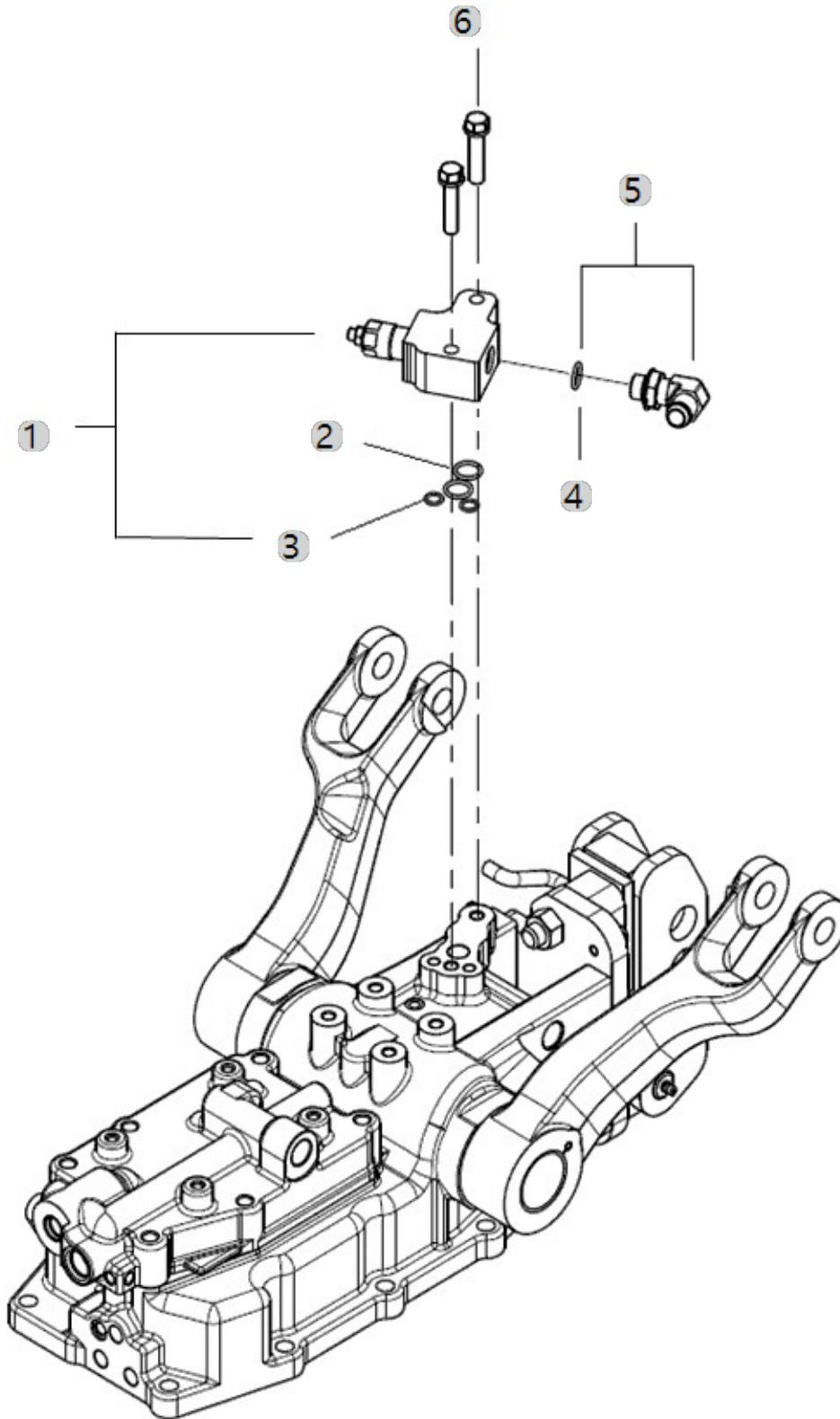



F10040

BRANSON 15R  
TM\_US\_FL(AC01899)

(STOP VALVE)

Year/Month

2022-12-14

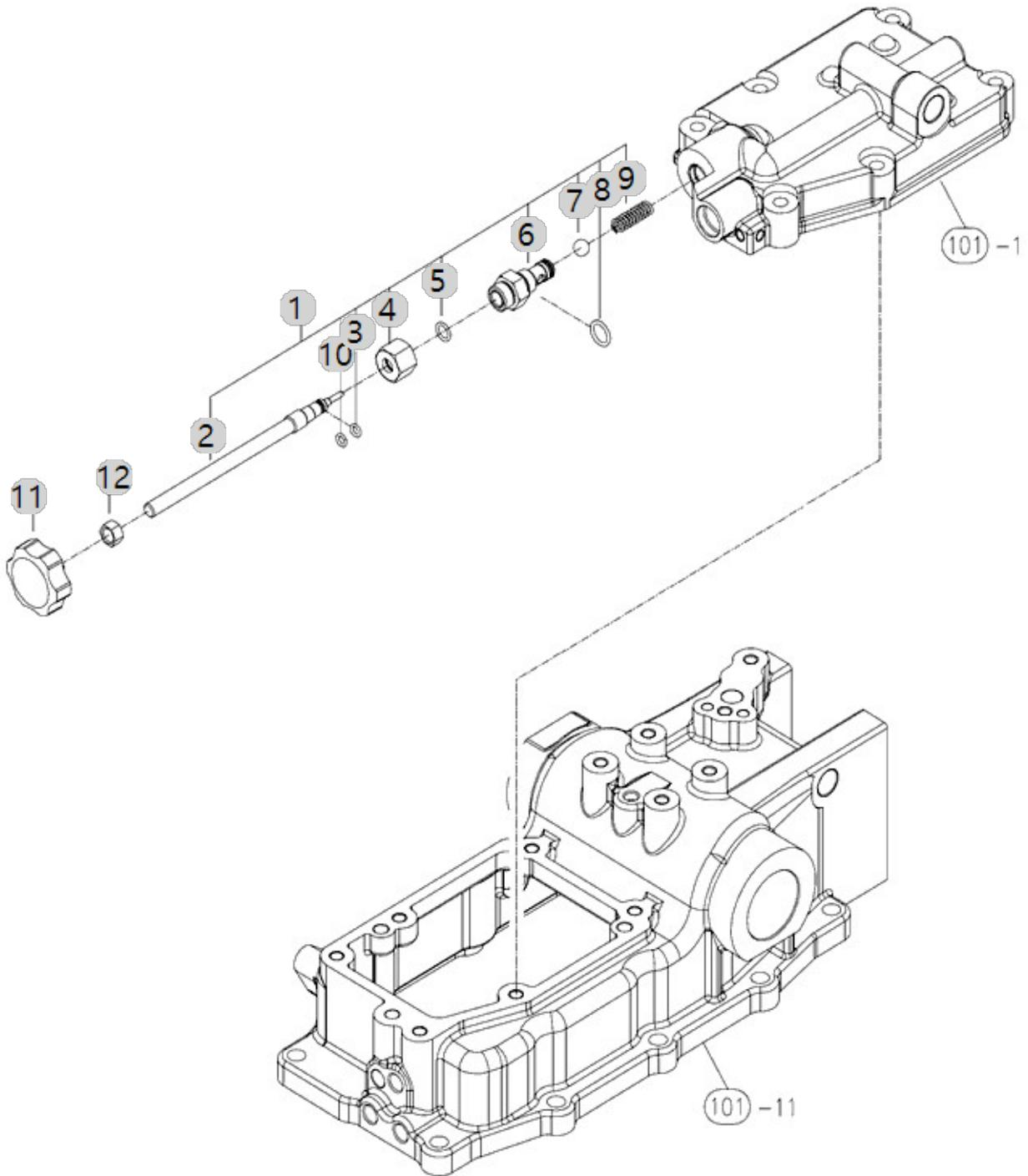



F10061

BRANSON 15R  
TM\_US\_FL(AC01899)

(DRAFT/POSITION CONTROL LEVER)

Year/Month

2022-12-14

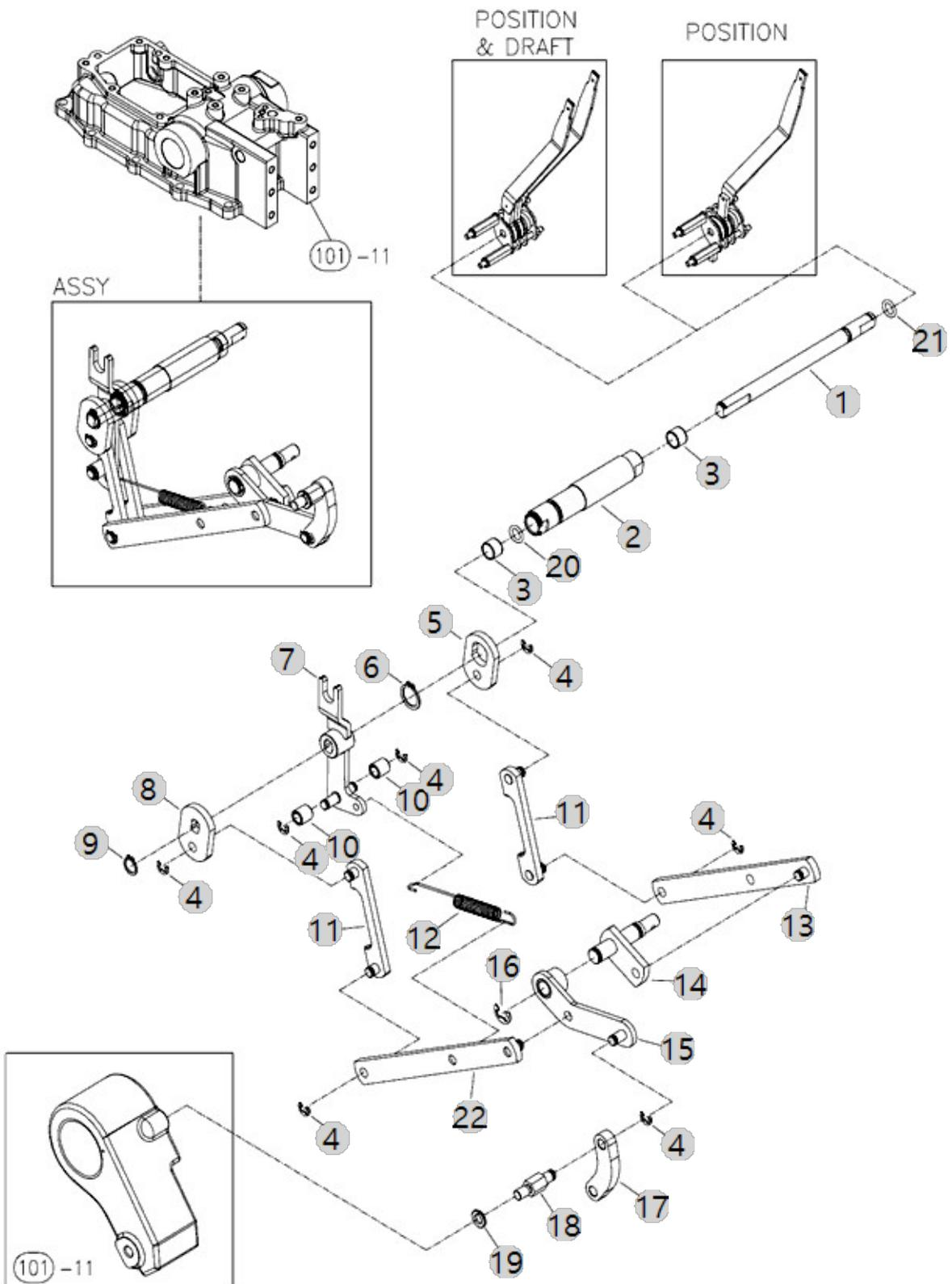





F10063

BRANSON 15R  
TM\_US\_FL(AC01899)

(DRAFT CONTROL)

Year/Month

2022-12-14

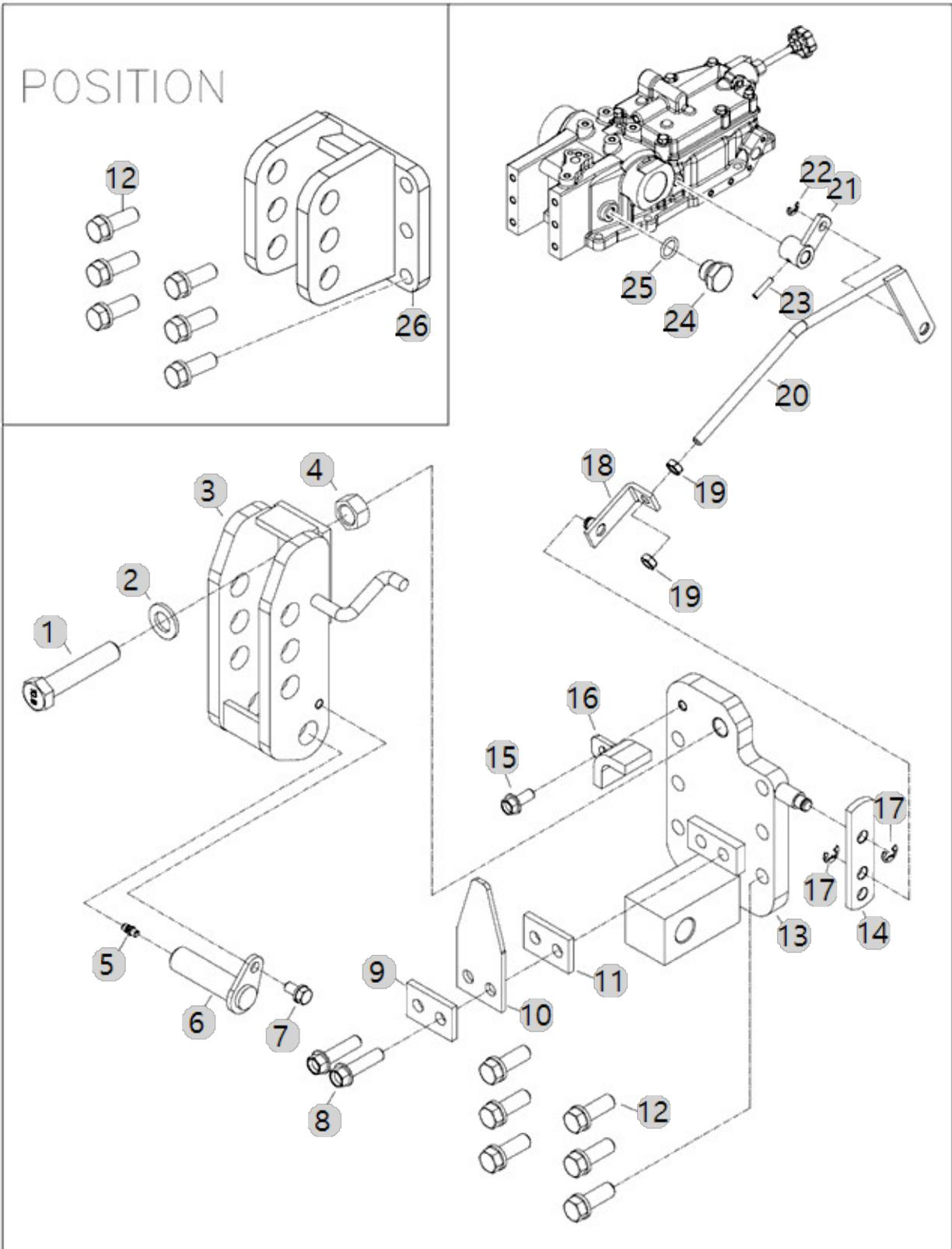



F10064

BRANSON 15R  
TM\_US\_FL(AC01899)

(POSITION CONTROL LEVER)

Year/Month

2022-12-14

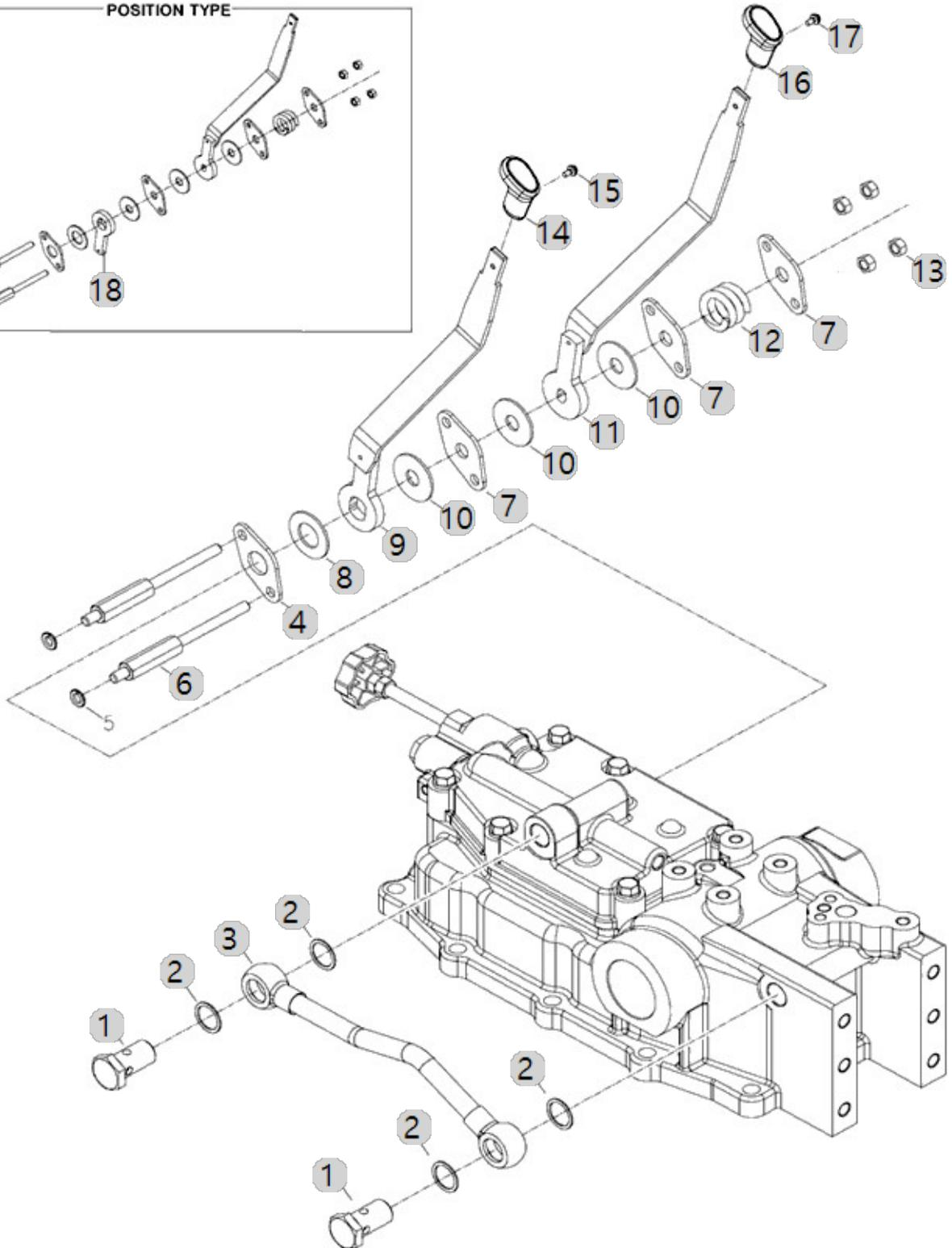
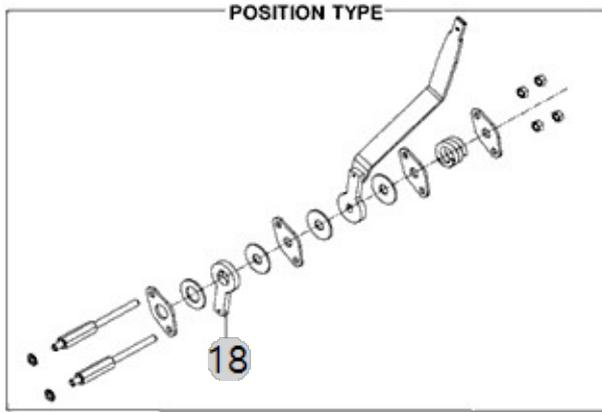



F11020

BRANSON 15R  
TM\_US\_FL(AC01899)

(LEVER ASS'Y, RANGE SHIFT)

Year/Month

2022-12-14

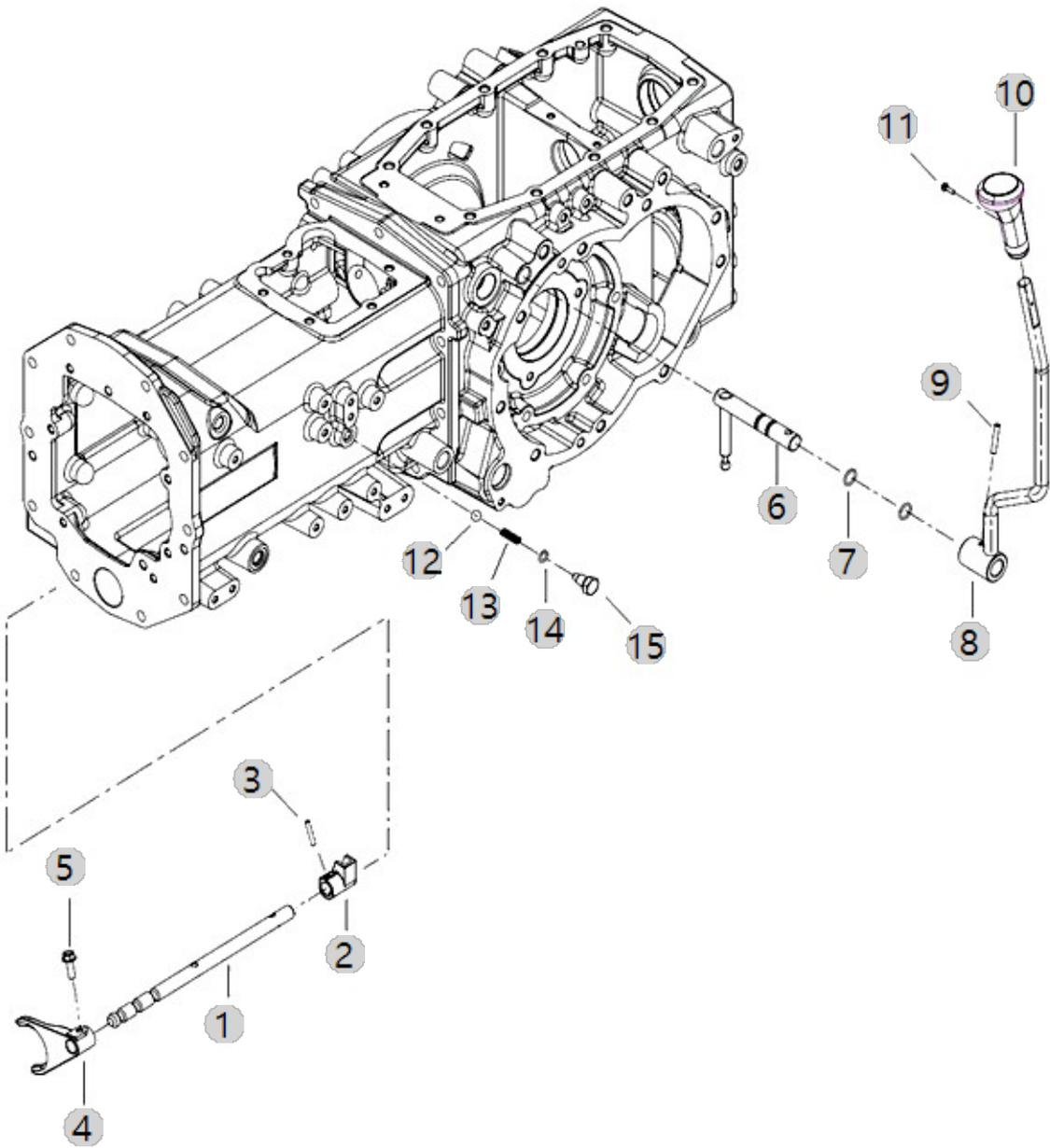



F11060

(DIFFERENTIAL LOCK)

Year/Month

BRANSON 15R  
TM\_US\_FL(AC01899)

2022-12-14

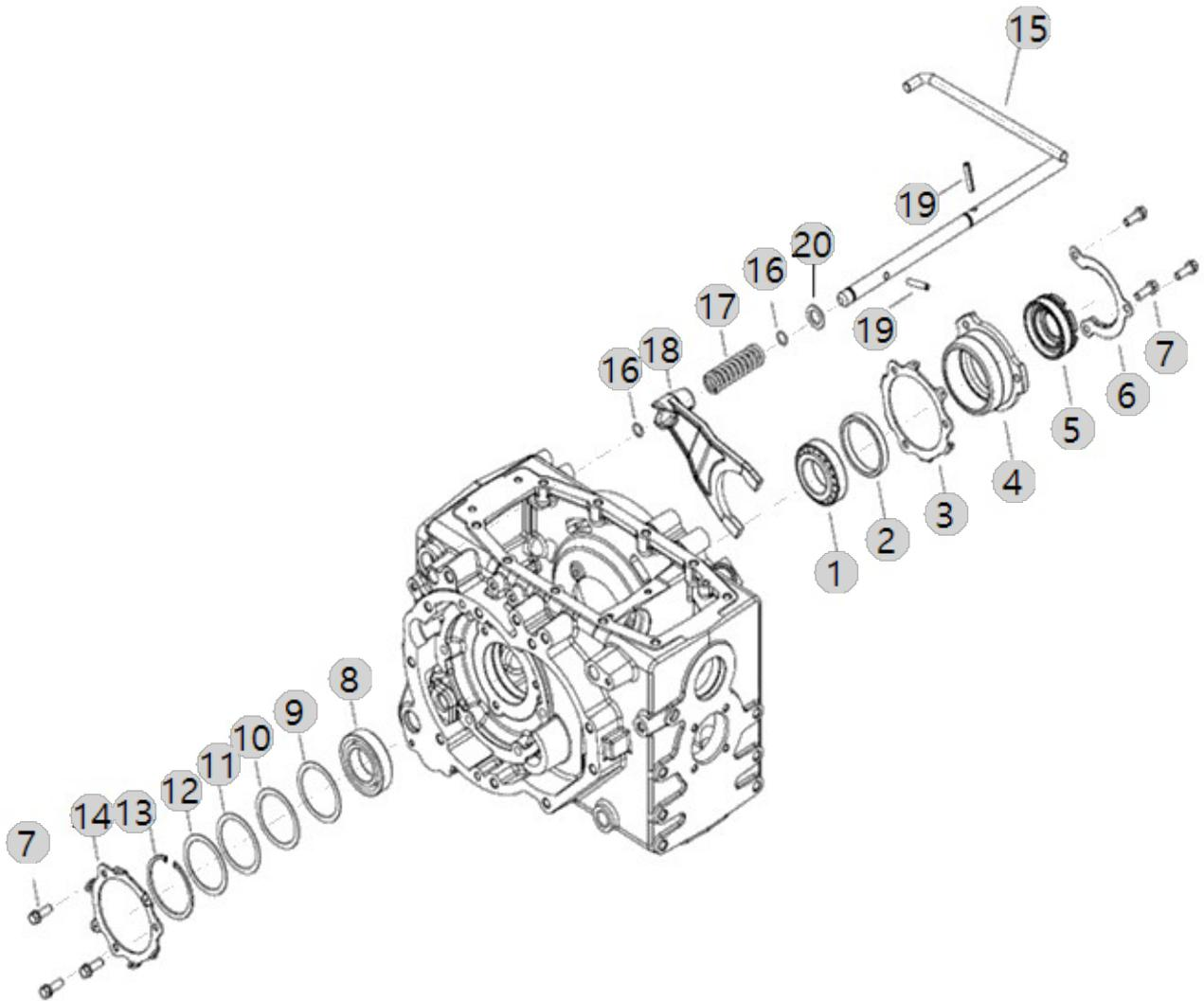





F11080

BRANSON 15R  
TM\_US\_FL(AC01899)

(4WD LEVER)

Year/Month

2022-12-14

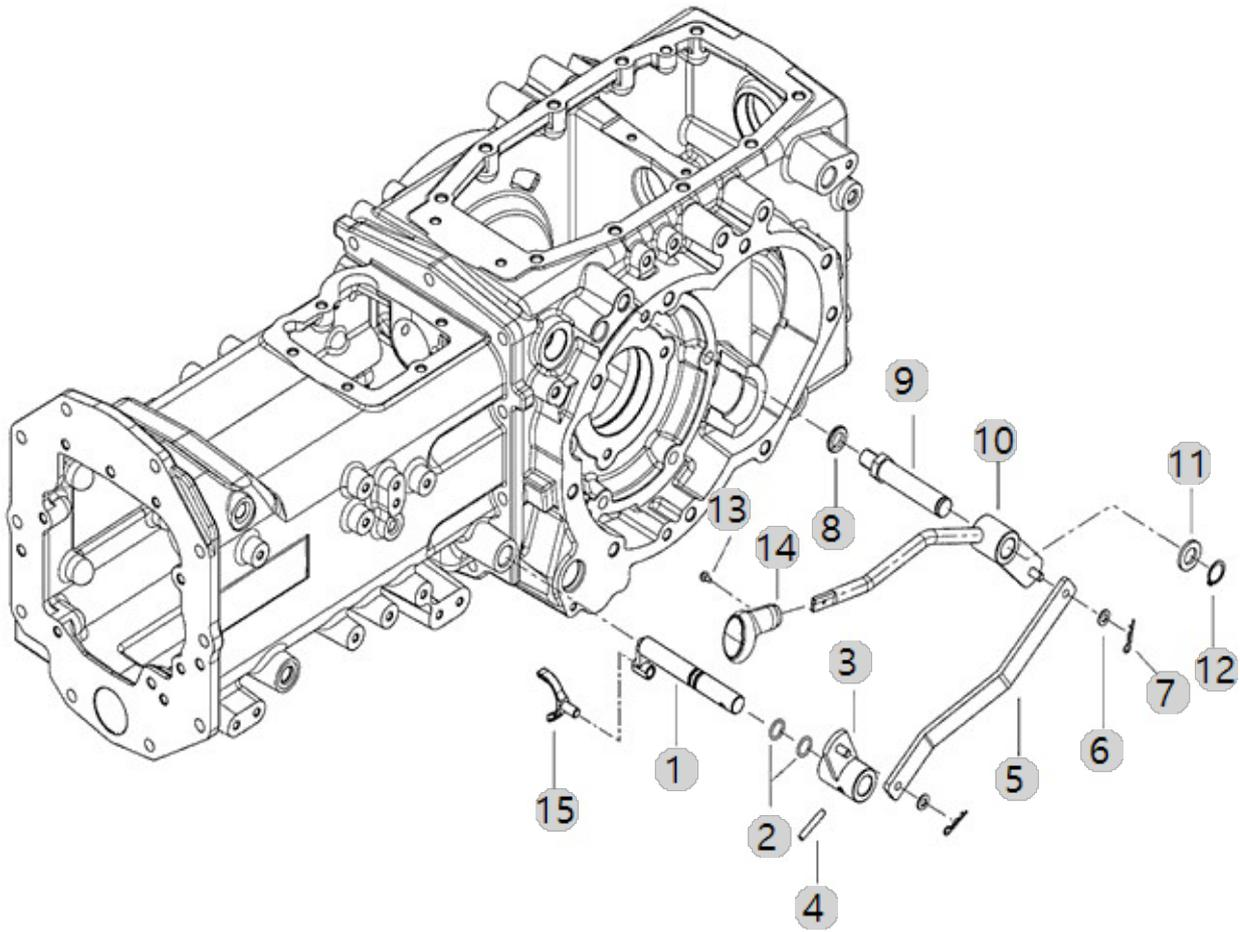



G01020

3015R\_US\_FL  
(AC02154)

# BONNET

Year/Month

2022-12-14

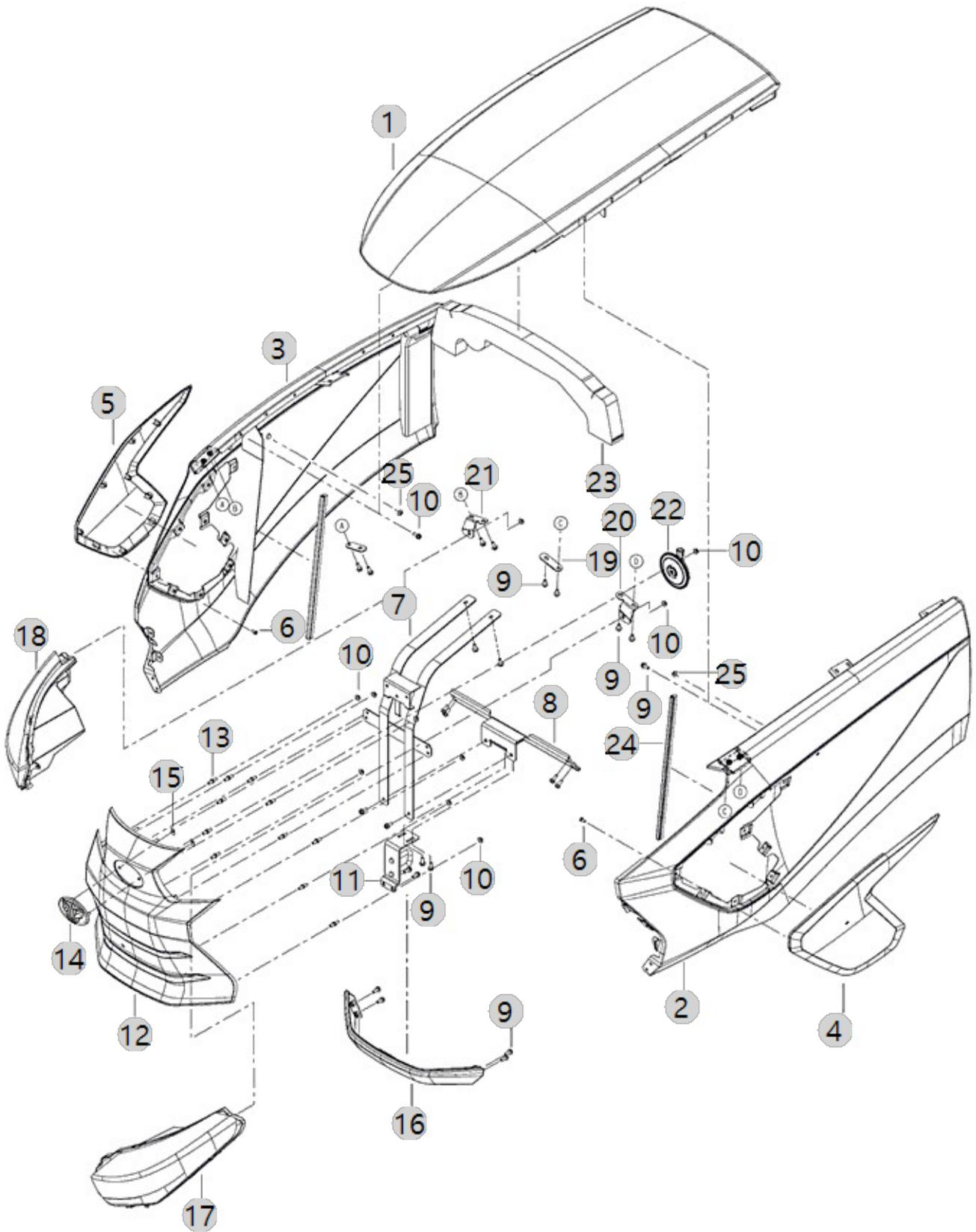



G01040

3015R\_US\_FL  
(AC02154)

LOCKING ASS'Y, BONNET

Year/Month

2022-12-14

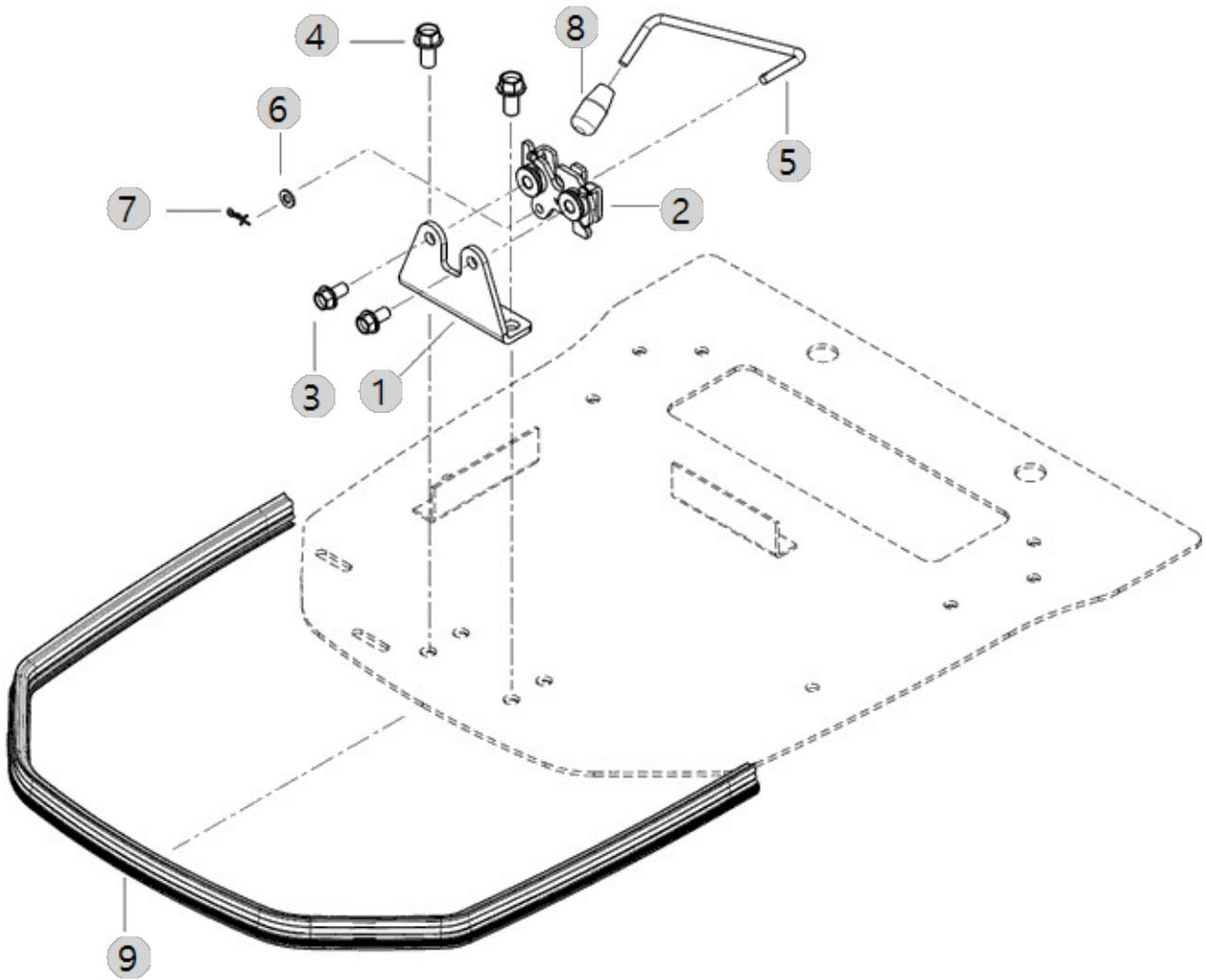



G01060-B

3015R\_US\_FL  
(AC02154)

(BONNET SUPPORT)

Year/Month

2022-12-14

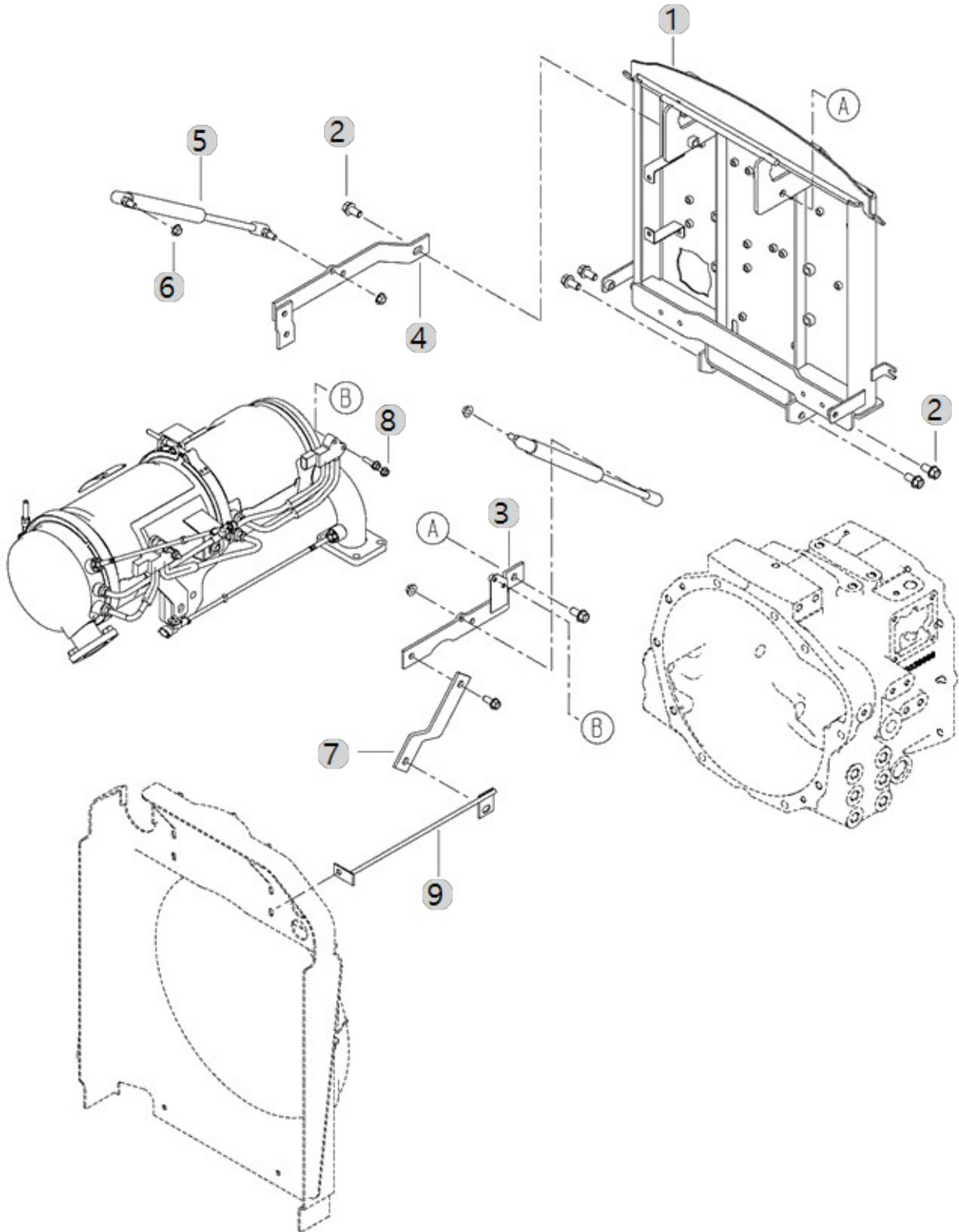





G01062

3015R\_US\_FL  
(AC02154)

FIXED BRACKET, BONNET

Year/Month

2022-12-14

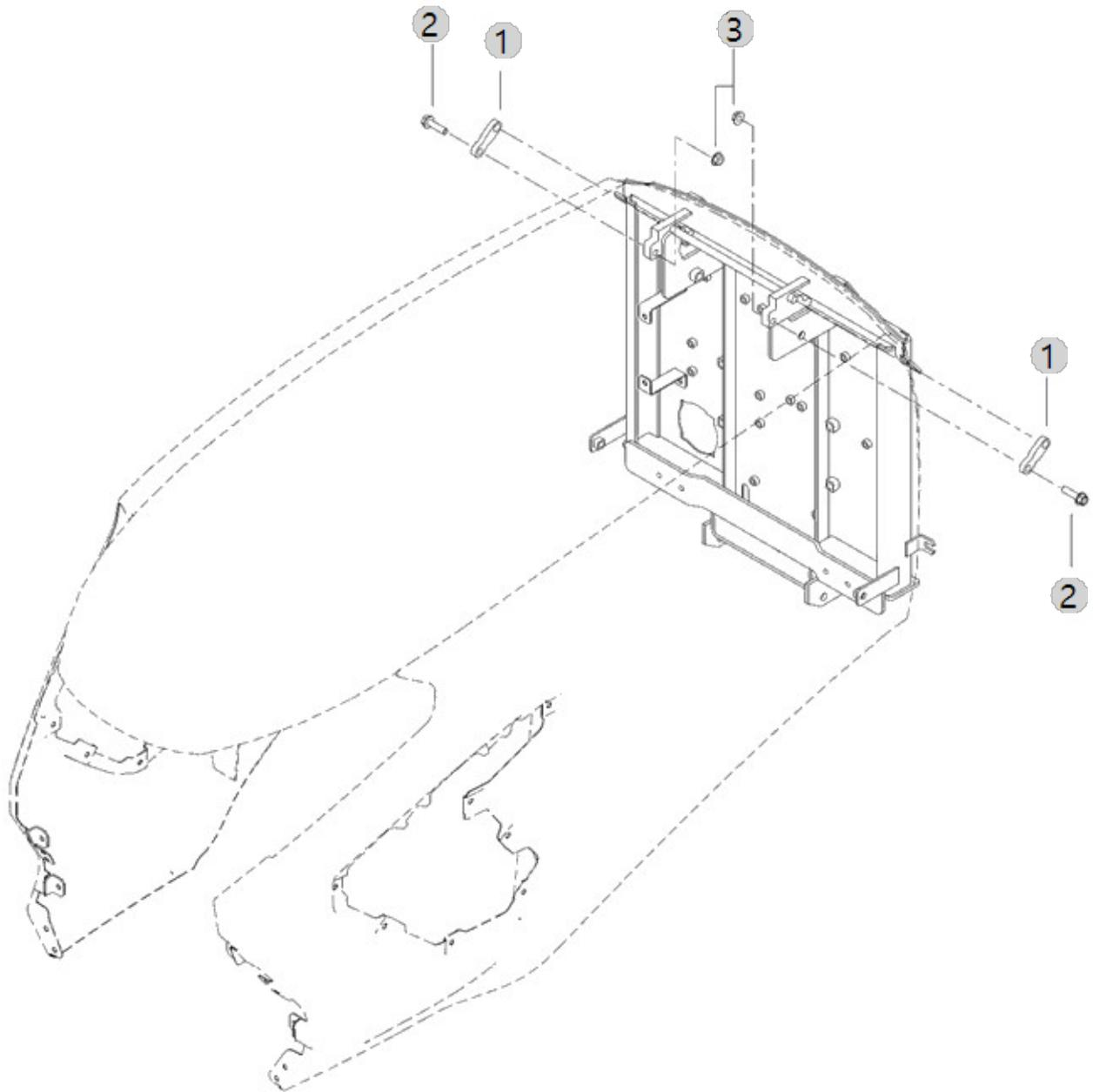



G01080

3015R\_US\_FL  
(AC02154)

# FRONT AXLE BRACKET

Year/Month

2022-12-14

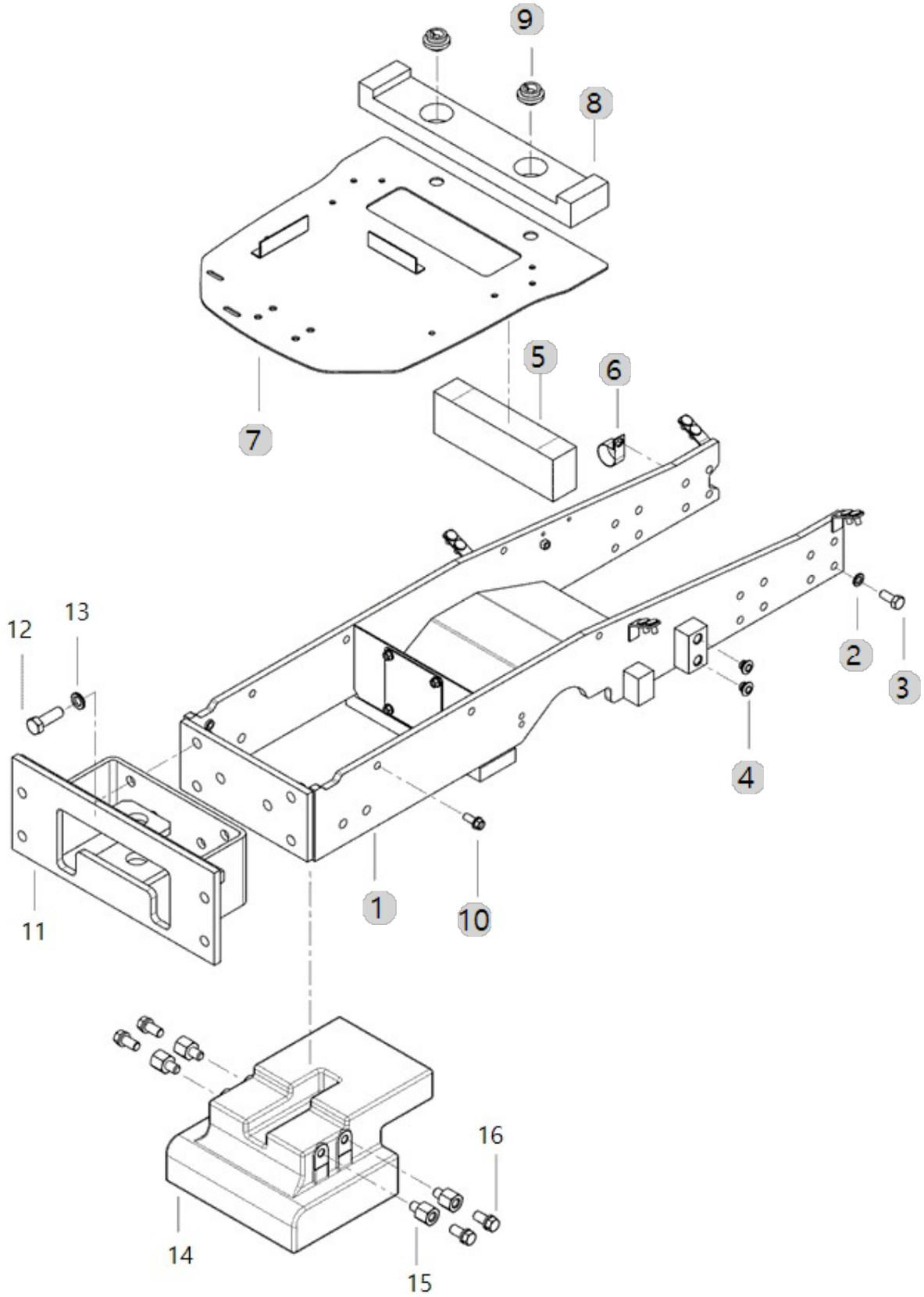



G04060

3015R\_US\_FL  
(AC02154)

### FOOT REST ASS'Y

Year/Month

2022-12-14

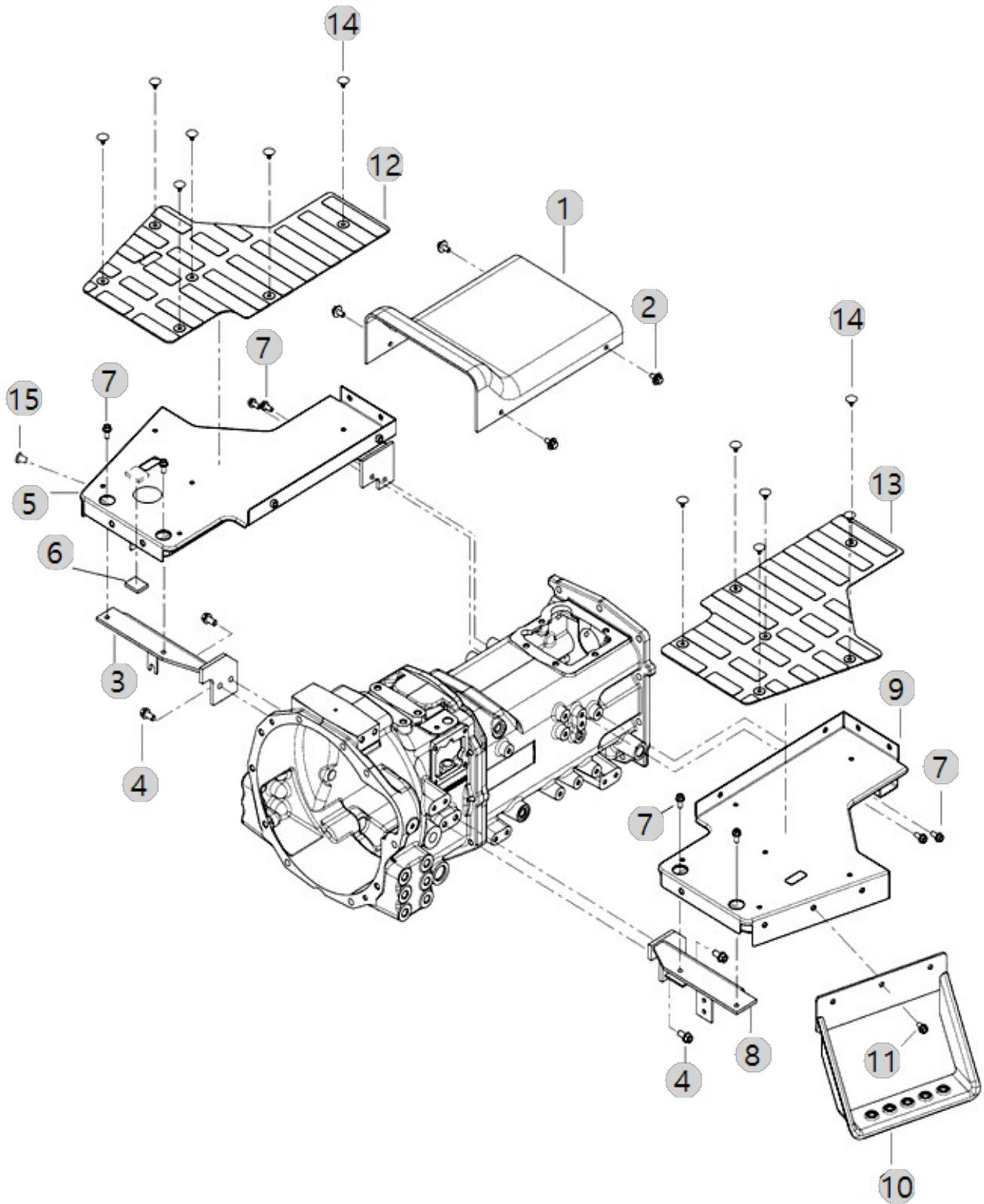



G04070

3015R\_US\_FL  
(AC02154)

SEAT

Year/Month

2022-12-14

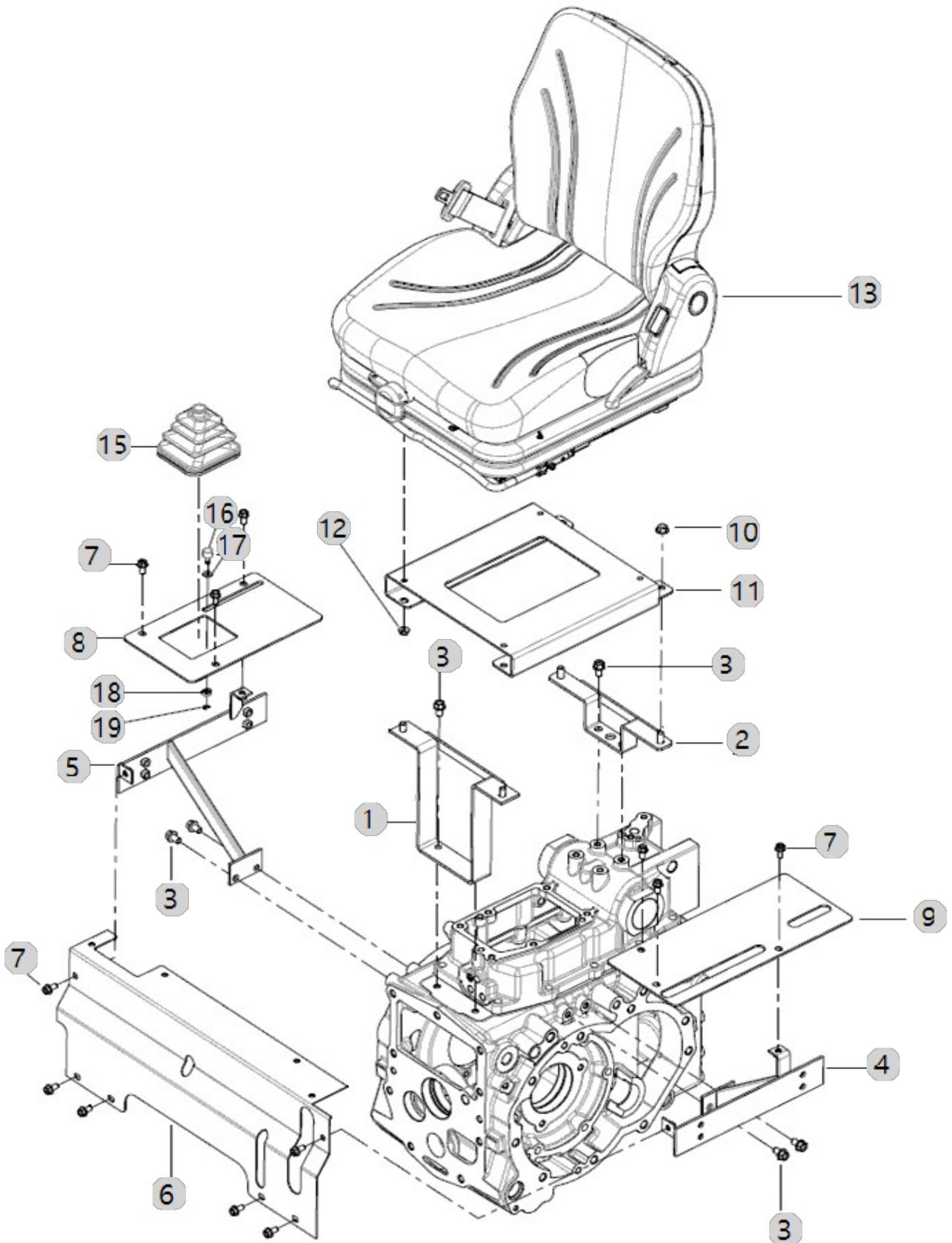









G04120

3015R\_US\_FL  
(AC02154)

ROPS FRAME ASS'Y

Year/Month

2022-12-14

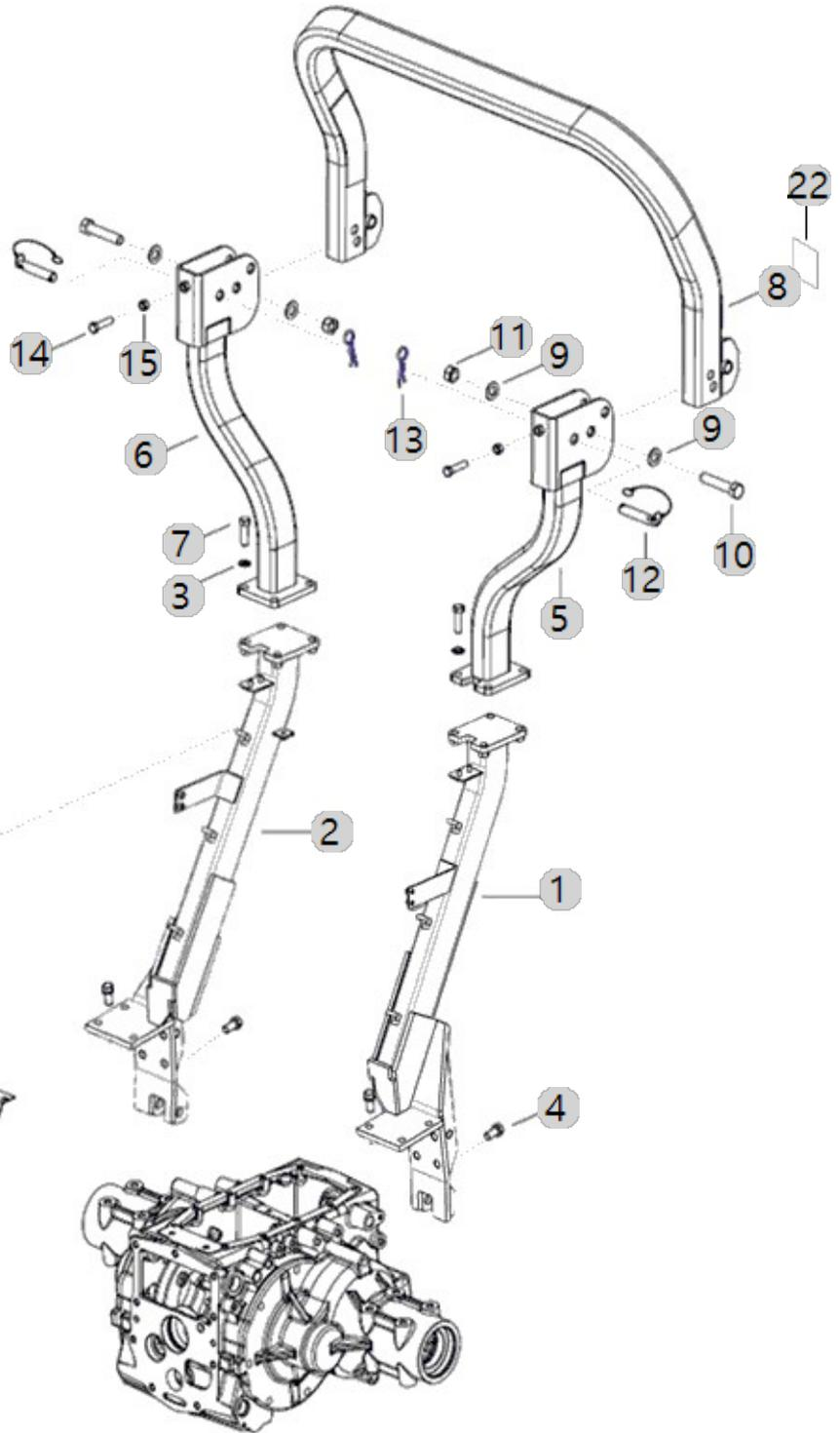
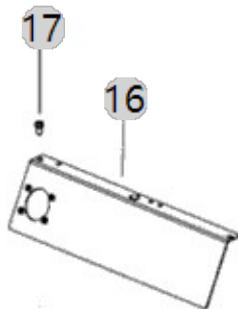
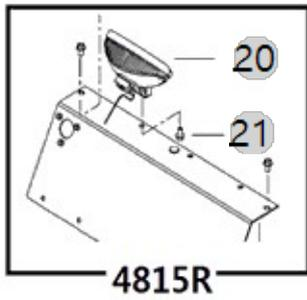
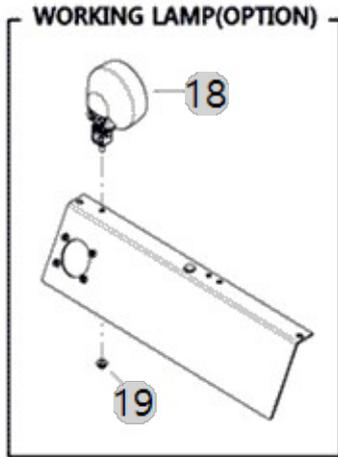



G05020

3015R\_US\_FL  
(AC02154)

TOP LINK

Year/Month

2022-12-14

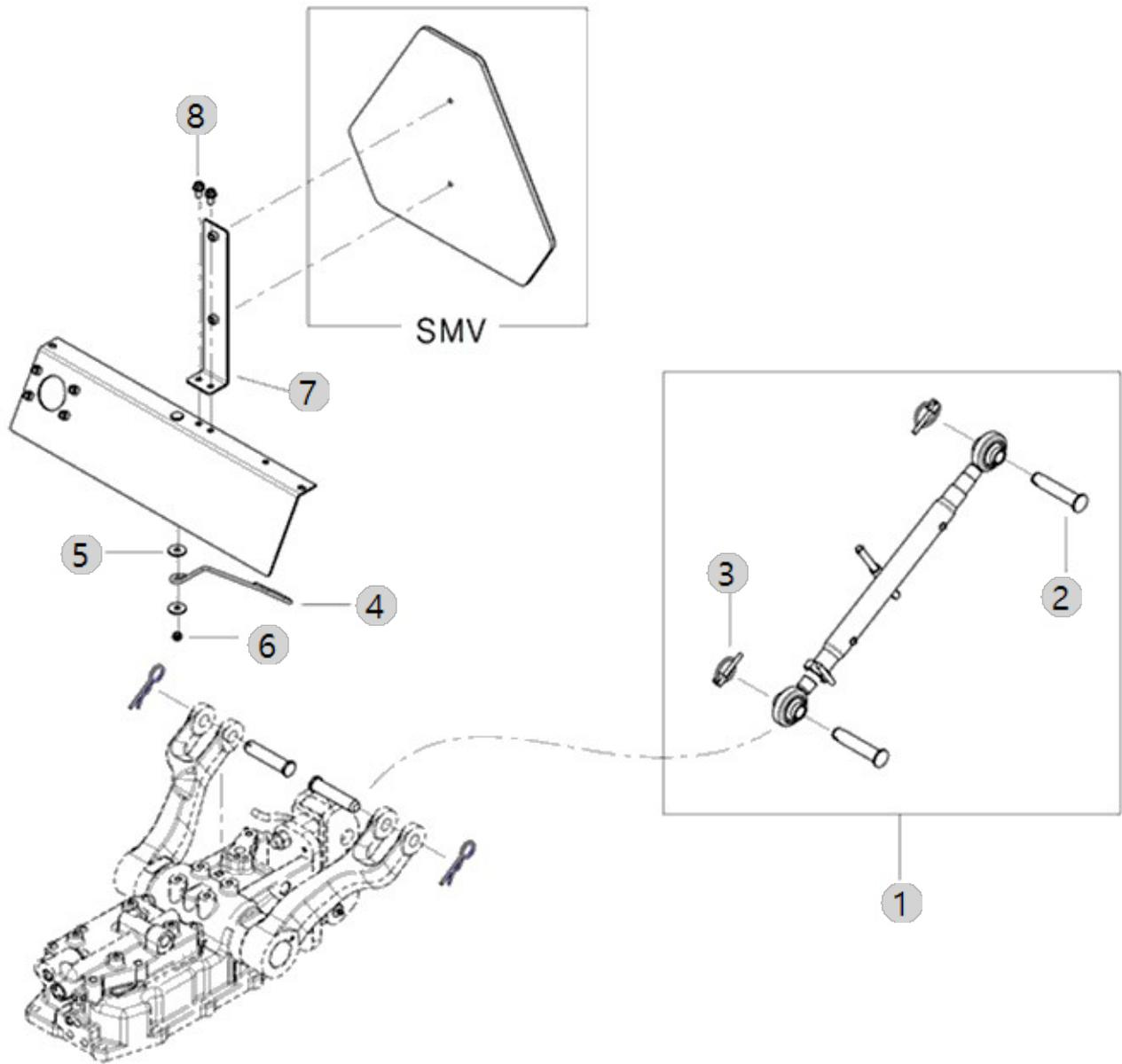



G05030

3015R\_US\_FL  
(AC02154)

LOWER LINK

Year/Month

2022-12-14

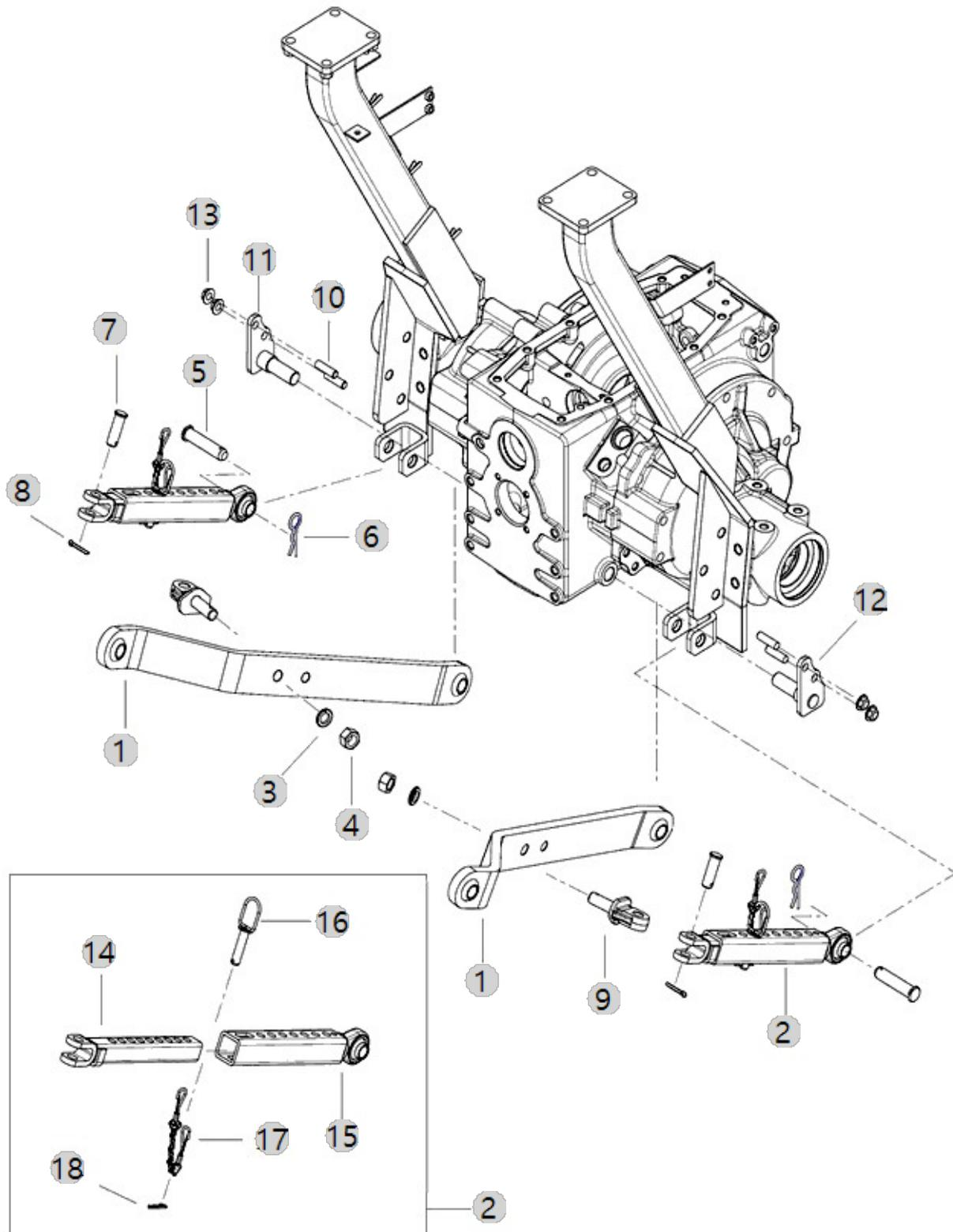





G05050

3015R\_US\_FL  
(AC02154)

LIFT LINK

Year/Month

2022-12-14

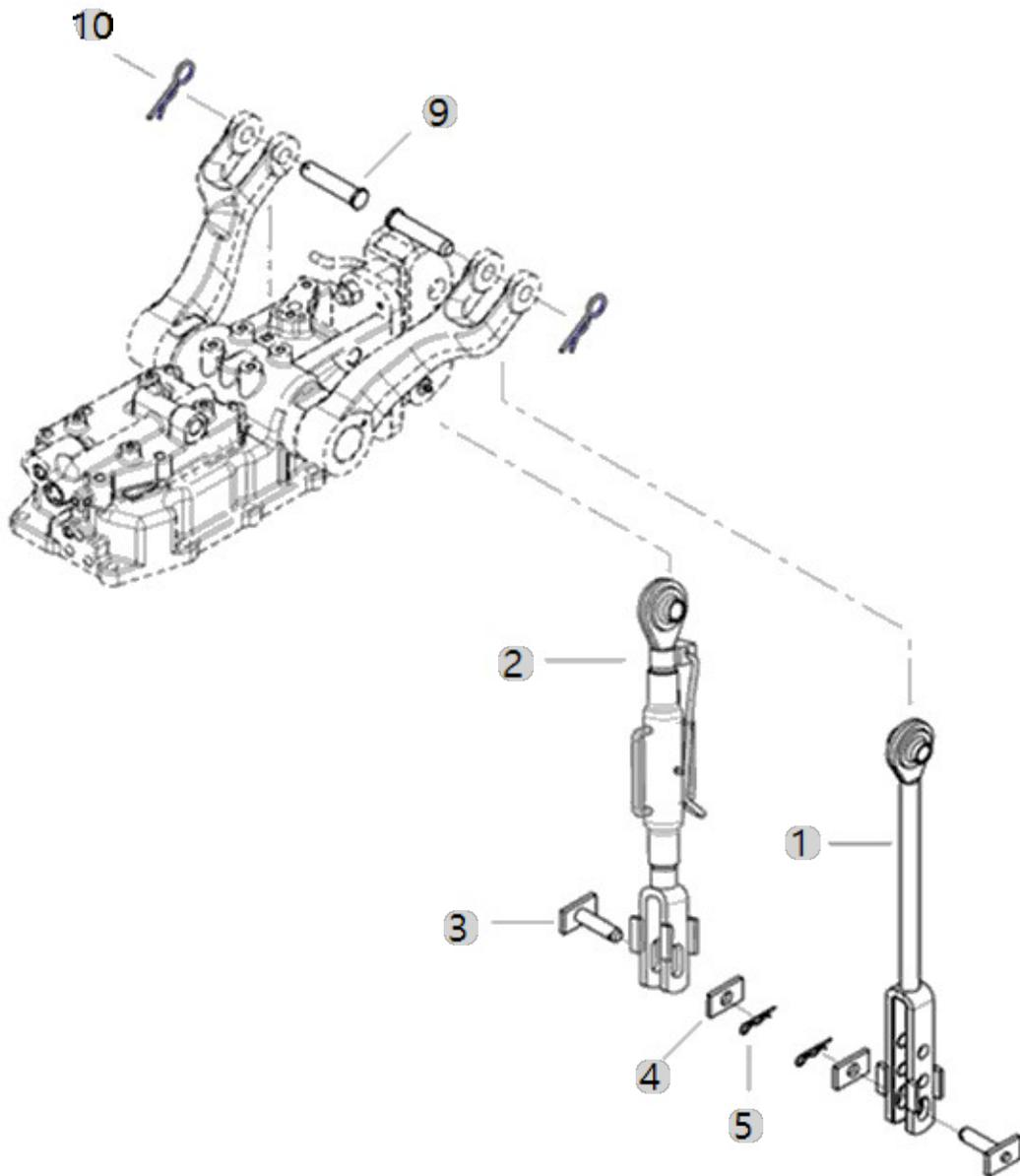



G05070

3015R\_US\_FL  
(AC02154)

### DRAWBAR HITCH

Year/Month

2022-12-14

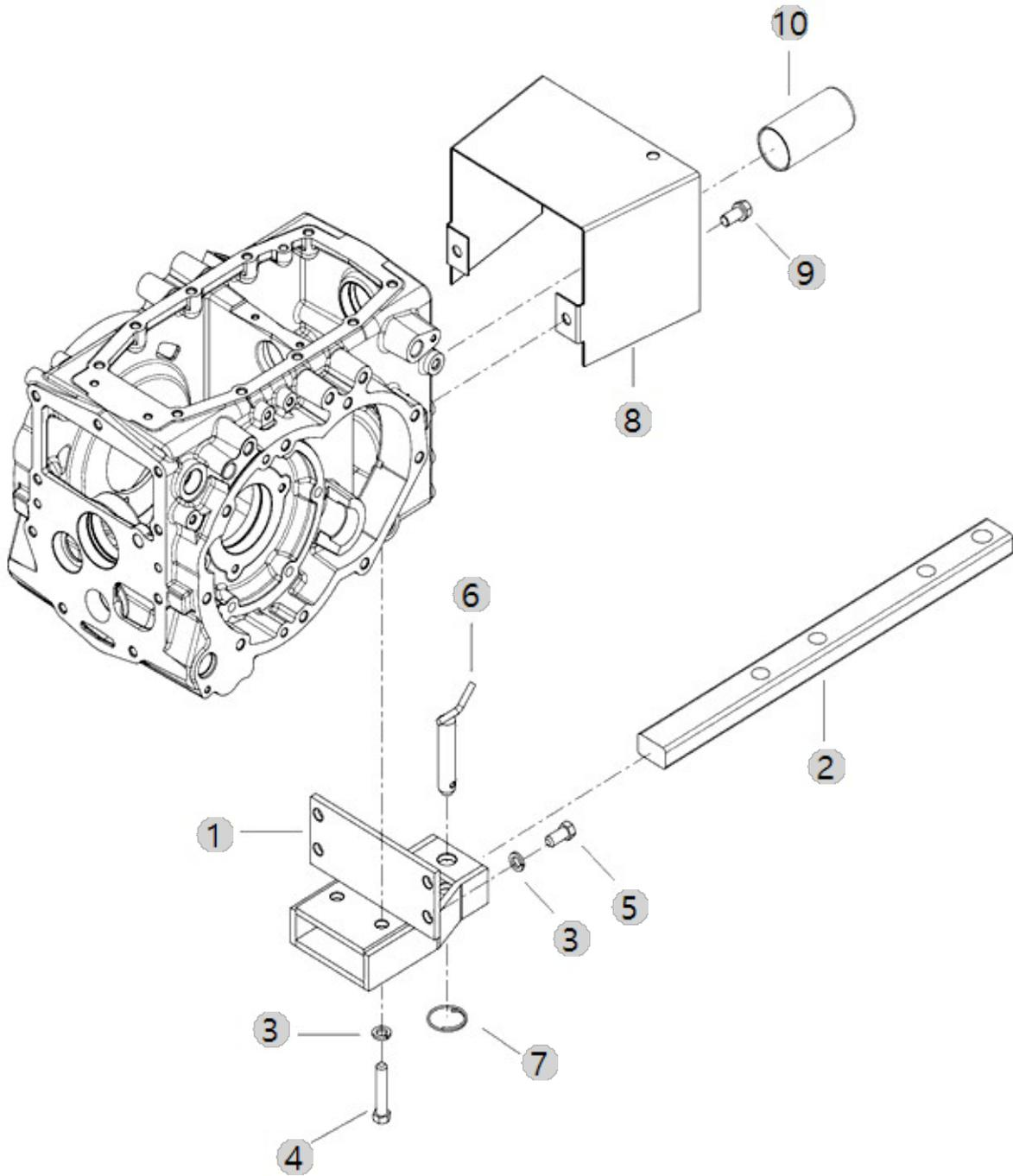



G05090

3015R\_US\_FL  
(AC02154)

### SIDE COVER

Year/Month

2022-12-14

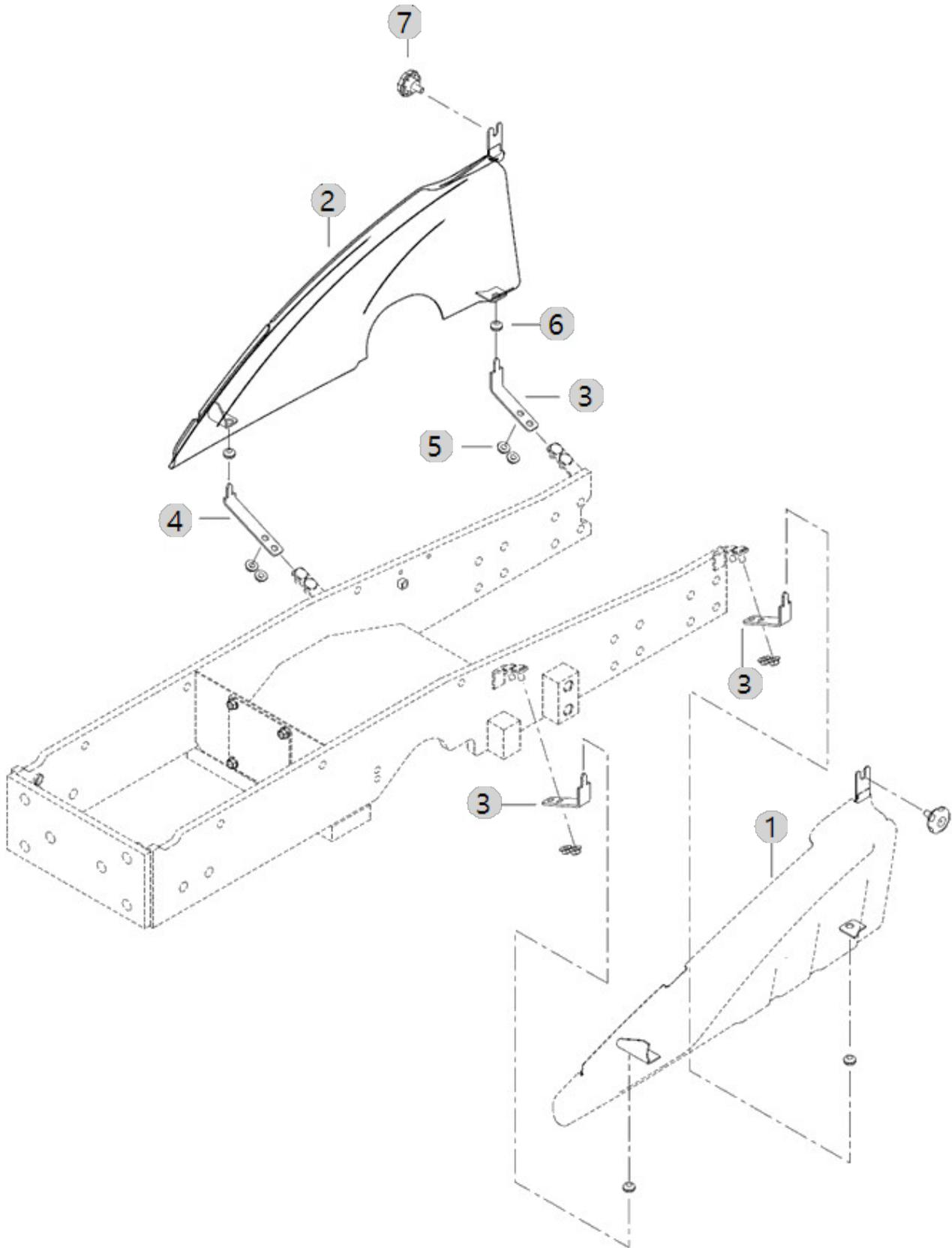



G06010

3015R\_US\_FL  
(AC02154)

TOOL BOX & CUP HOLDER

Year/Month

2022-12-14

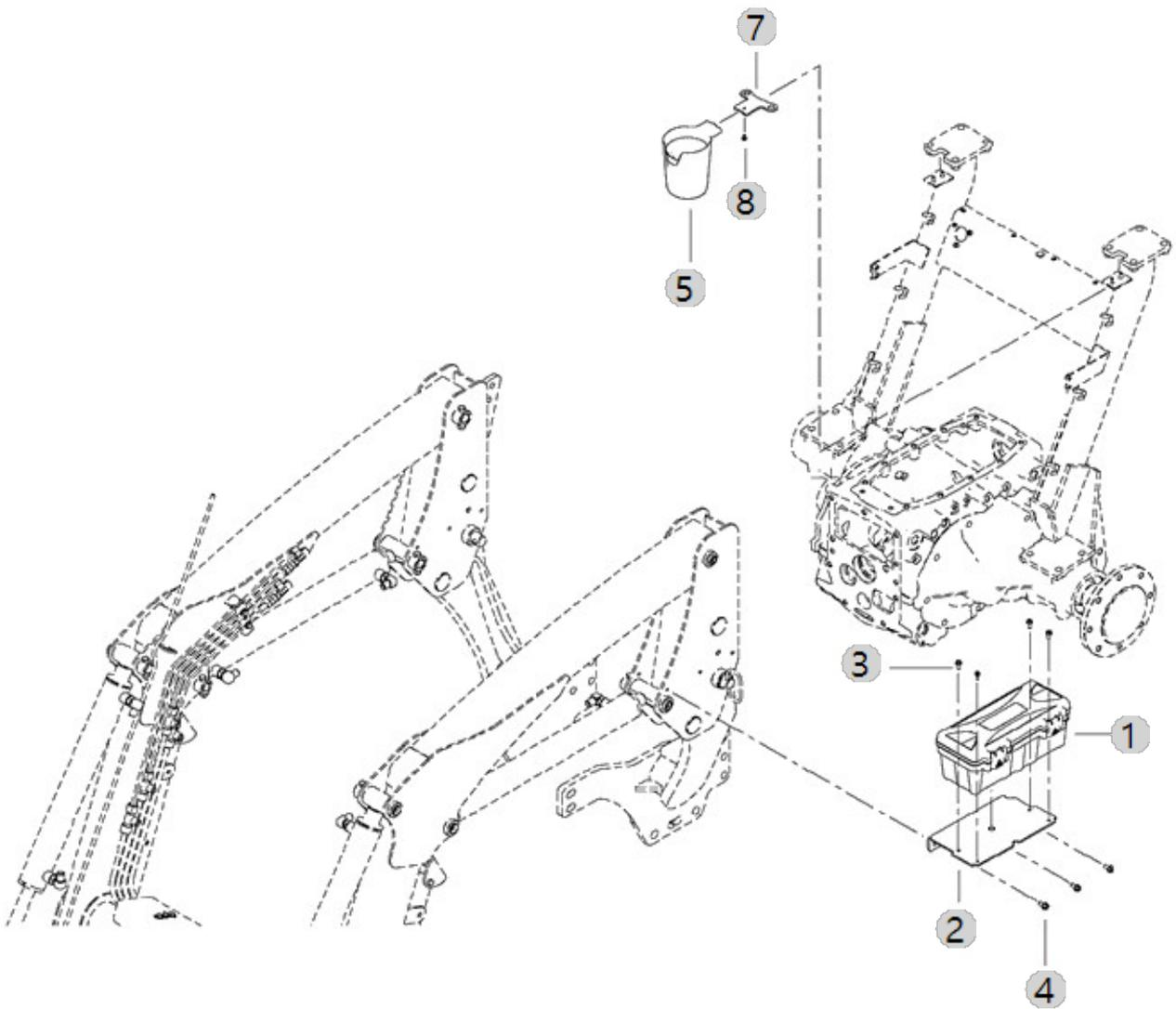





H01030

3015R\_US\_FL  
(AC02154)

BATTERY

Year/Month

2022-12-14

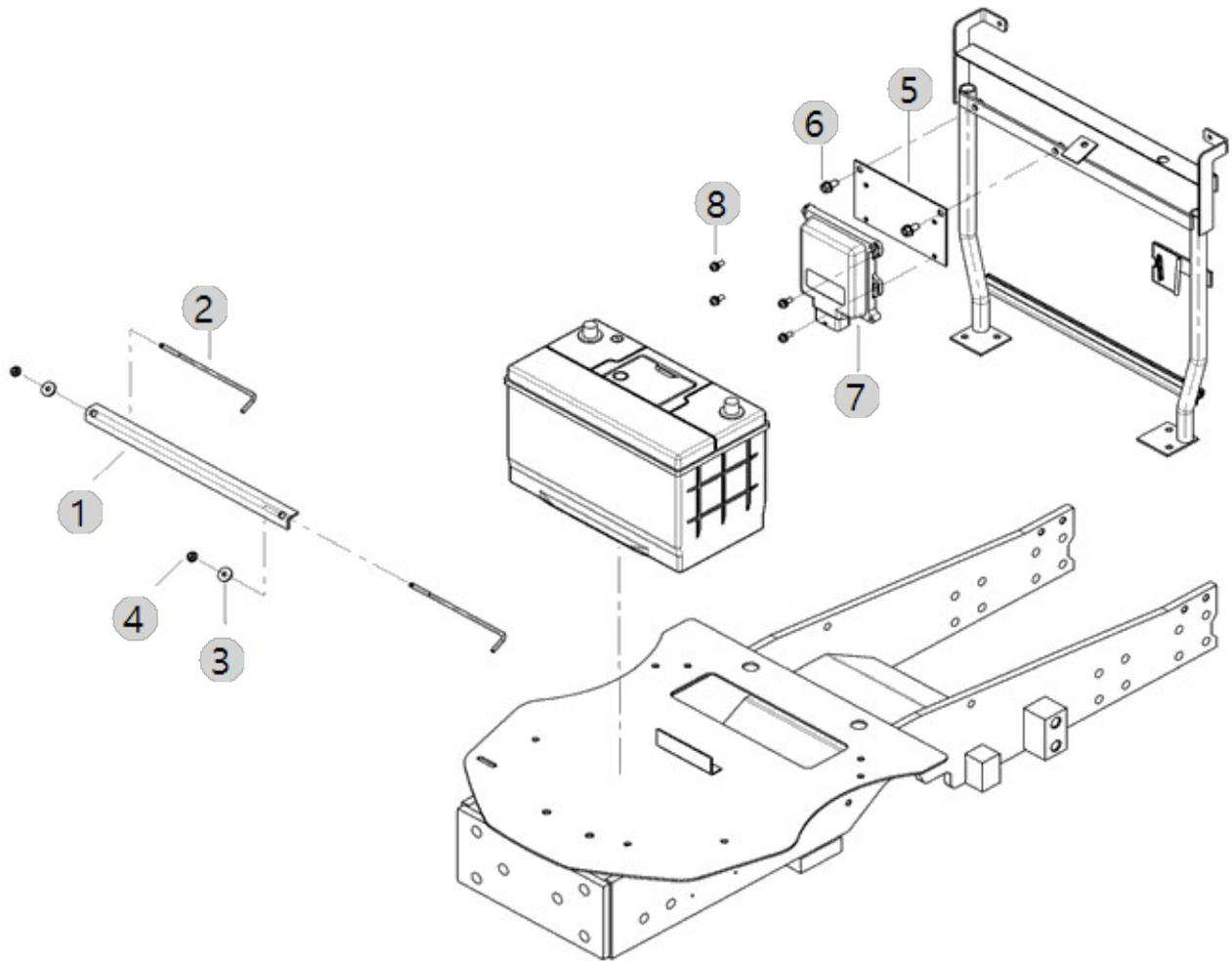



H03000

3015R\_US\_FL  
(AC02154)

HARNESS

Year/Month

2022-12-14

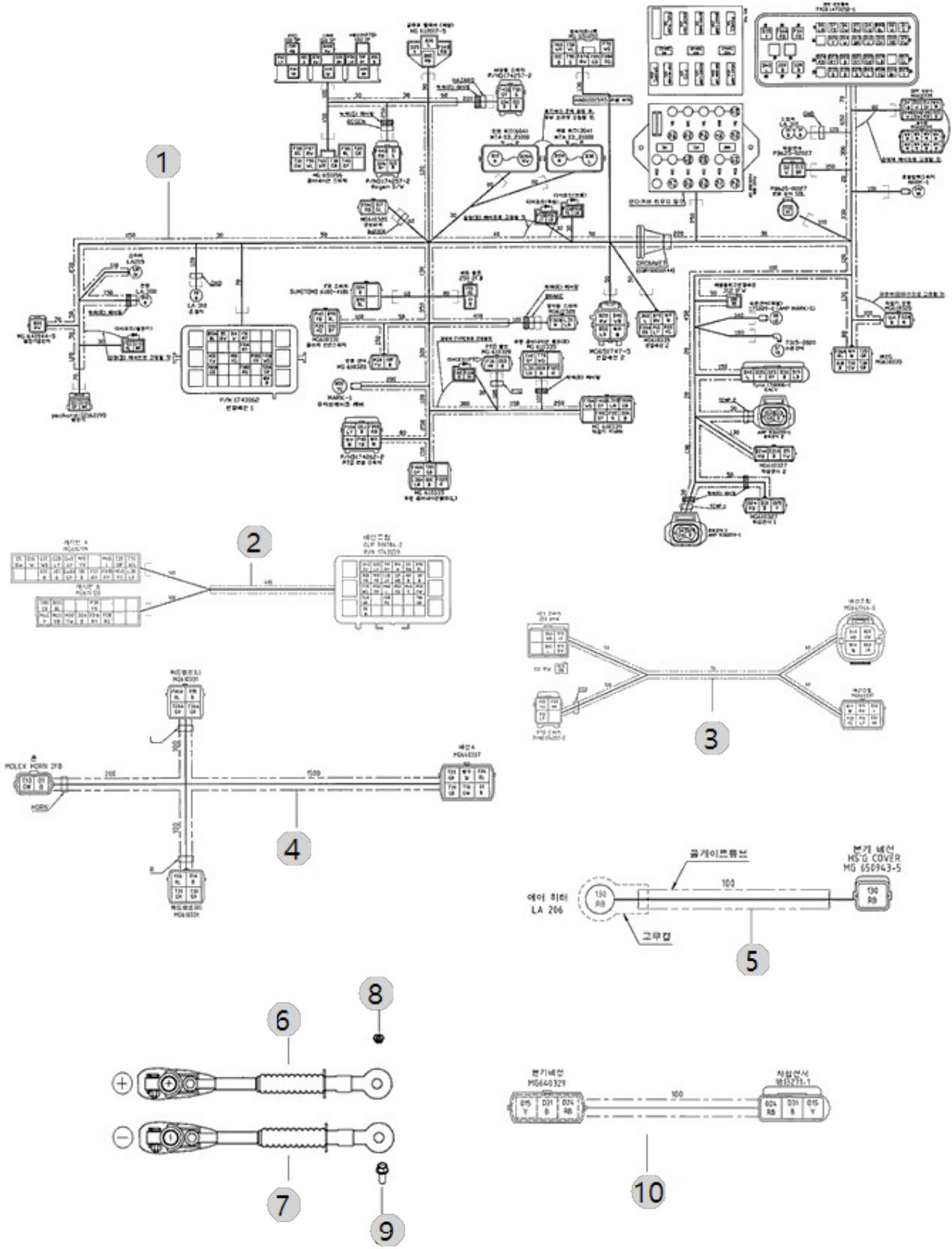



H04051

3015R\_US\_FL  
(AC02154)

# SWITCH/DASHBOARD

Year/Month

2022-12-14

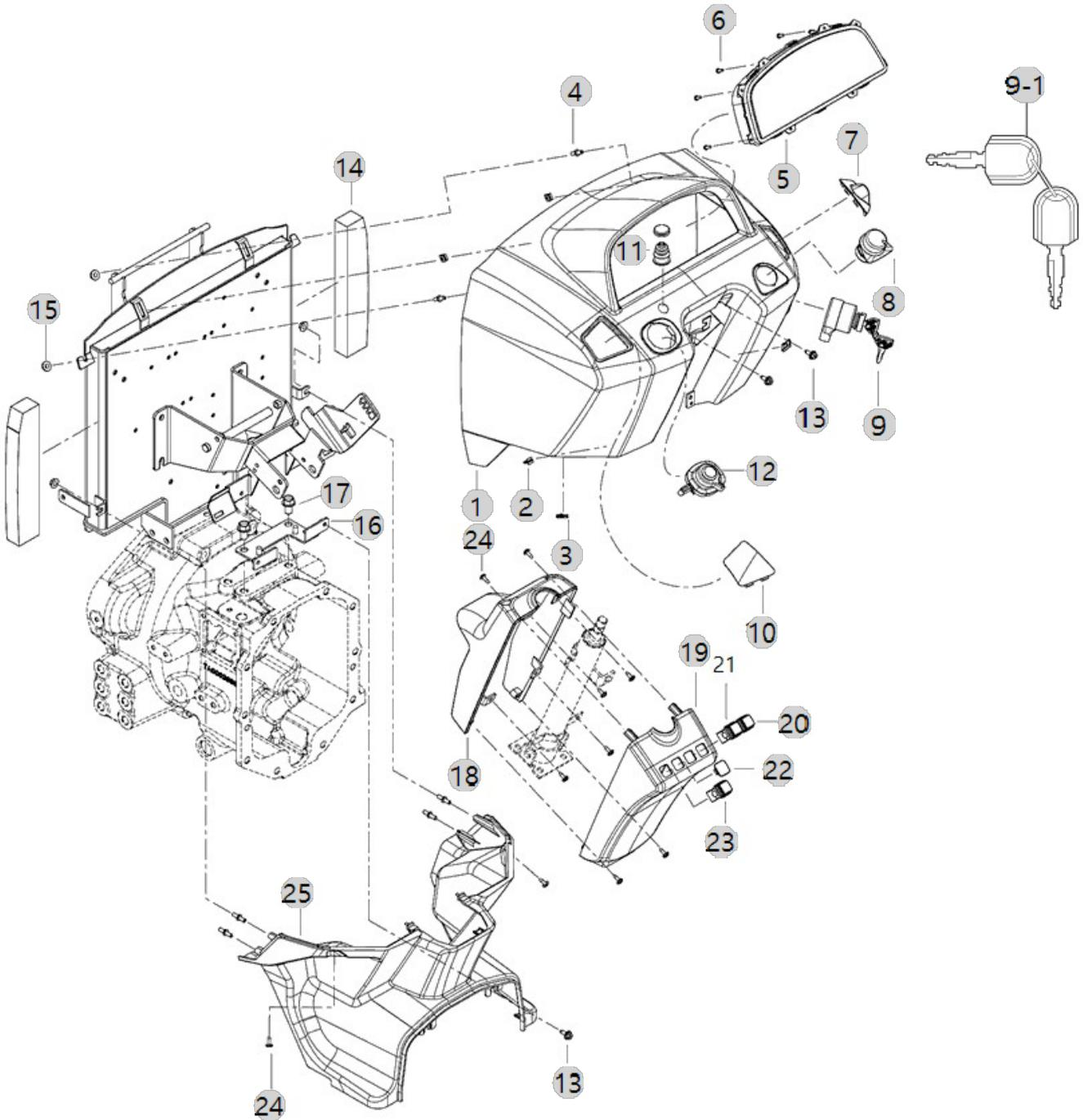



H04070

3015R\_US\_FL  
(AC02154)

# CONTROLLER

Year/Month

2022-12-14

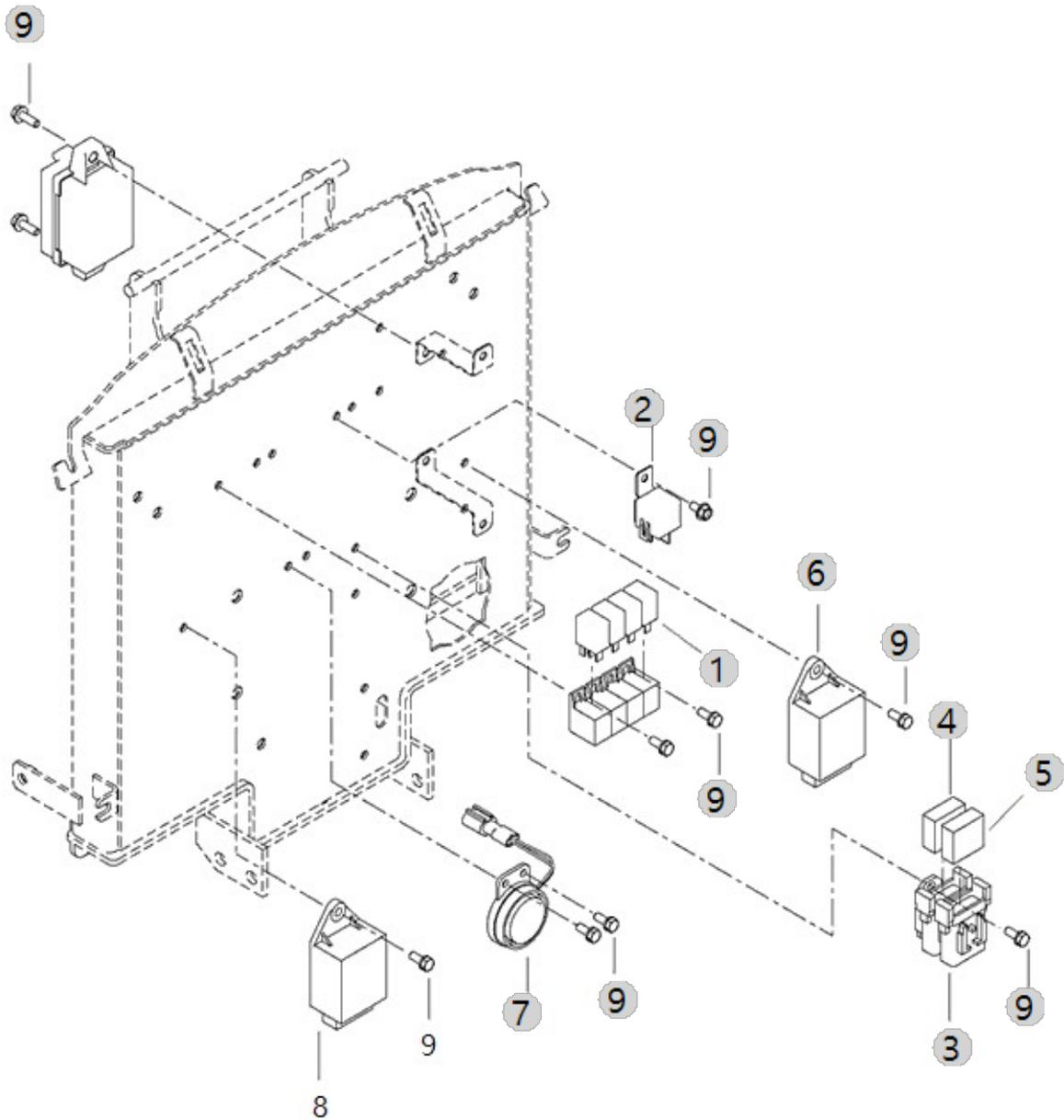





I03000

3015R\_US\_FL  
(AC02154)

NAME PLATE

Year/Month

2022-12-14

2515R

3015R

3515R

4215R

4815R

29



TYM

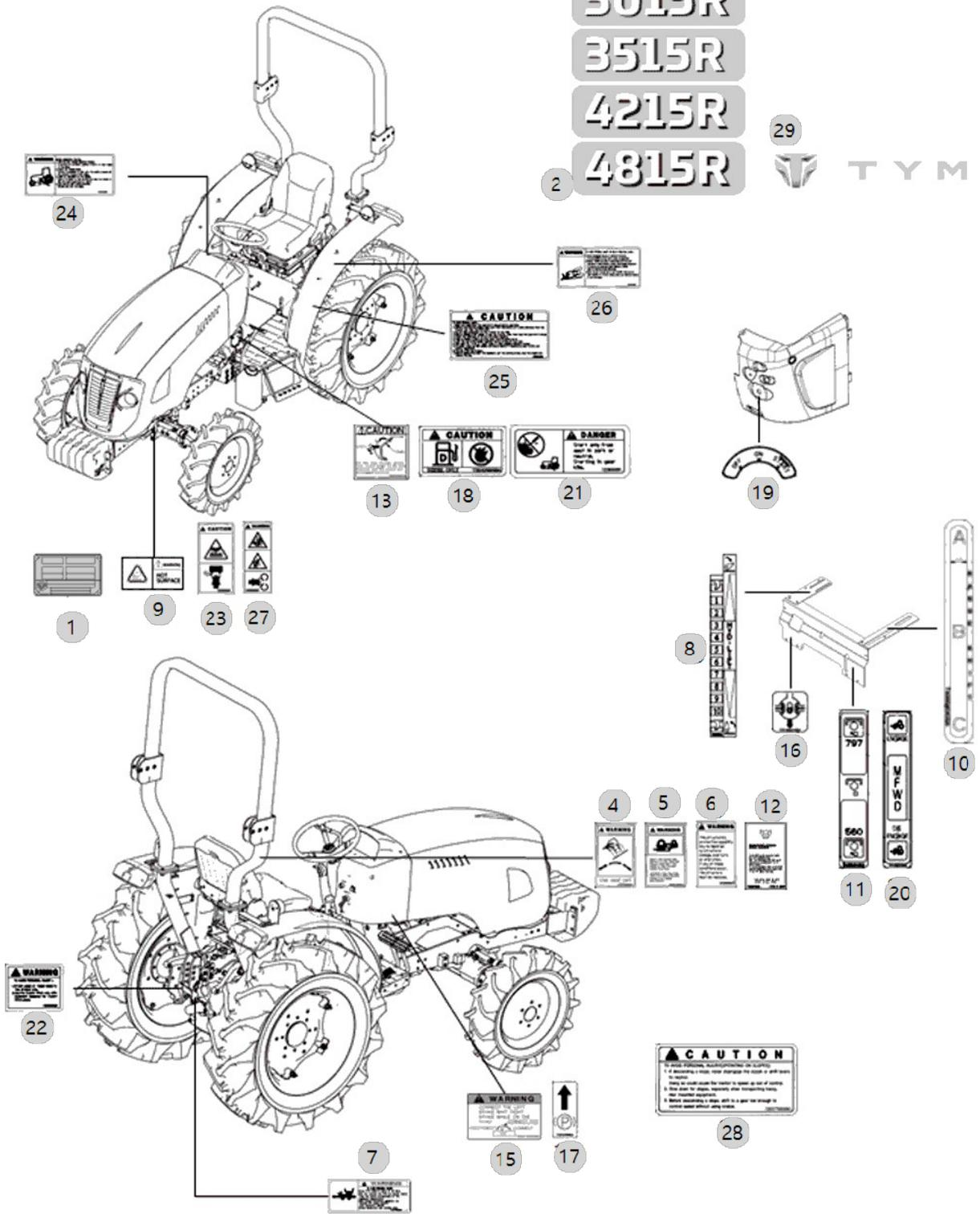



I06010

3015R\_US\_FL  
(AC02154)

### SUN VISOR(OPTION)

Year/Month

2022-12-14

